



(D) Videounterstützte Montageanleitung

(TR) Video destekli kurulum talimatları

(RU) инструкция по монтажу с помощью видеосигнала

(RO) Instrucțiuni de instalare acceptate video

(GB) Video-assisted assembly instructions

(IT) Istruzioni di montaggio video-assistite

(CZ) Instalační pokyny podporované videem

(PL) Instrukcje montażu wspomagane sygnałem wizyjnym

(FR) Instructions de montage assistées par vidéo

(NL) Video-ondersteunde montage-instructies

(HU) Video-támogatott telepítési utasítások

(SK) Inštaláčn  pokyny podporované videom

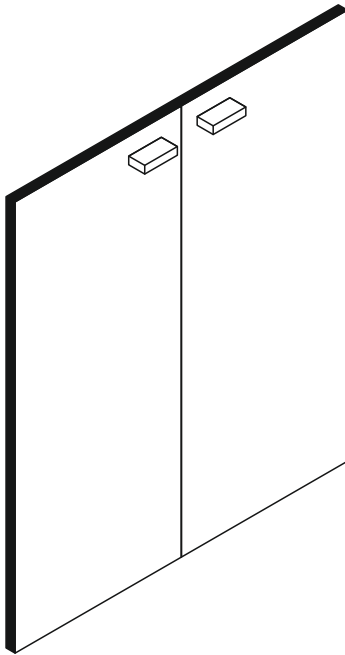

0202_2T T ren





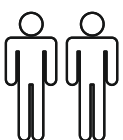
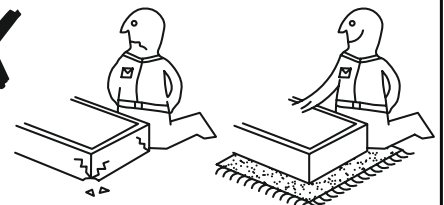
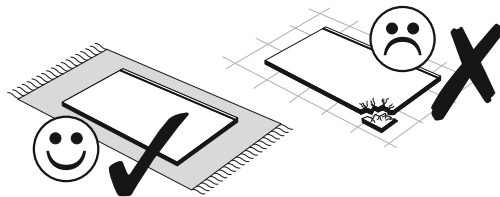
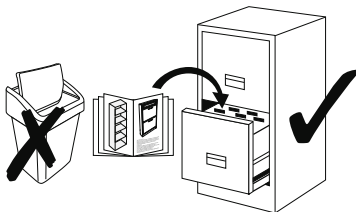
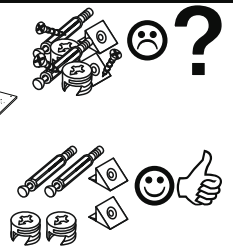
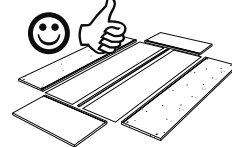
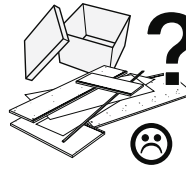
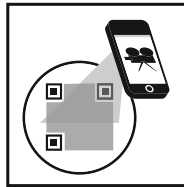
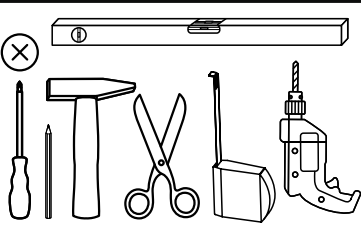

REPC-Nr.:

Service • Assistenza • Dienstverlening • Serwis
Servis • Szerviz • Сервисная служба

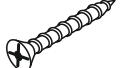



Das Ersatzteil-Anforderungsformular finden Sie auf <https://www.maeusbacher.de/ersatzteile/>

Beutel 1/2

1-37		1-80		1-329	
1x	4,5x25	8x	3,5x13	4x	M4x22
3-07		3-11		3-43	
2x		4x		4x	15er

Beutel 2/2

3-130		6-401	
4x		2x	

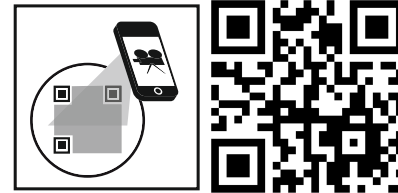
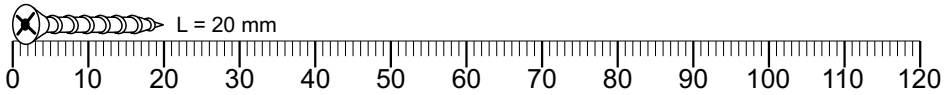

Colli 1/1

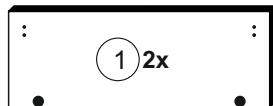

1036 x 381

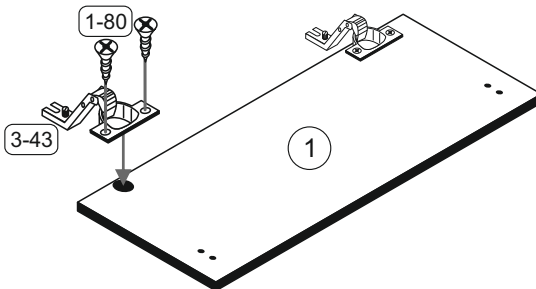
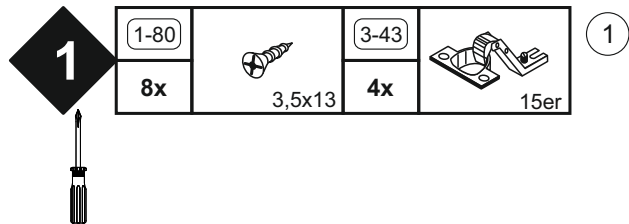

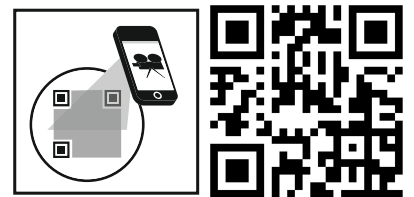
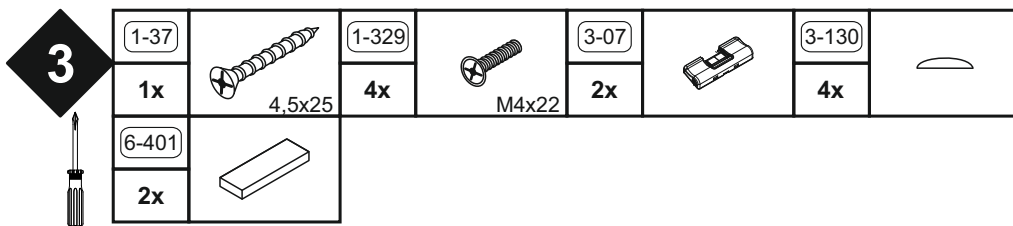
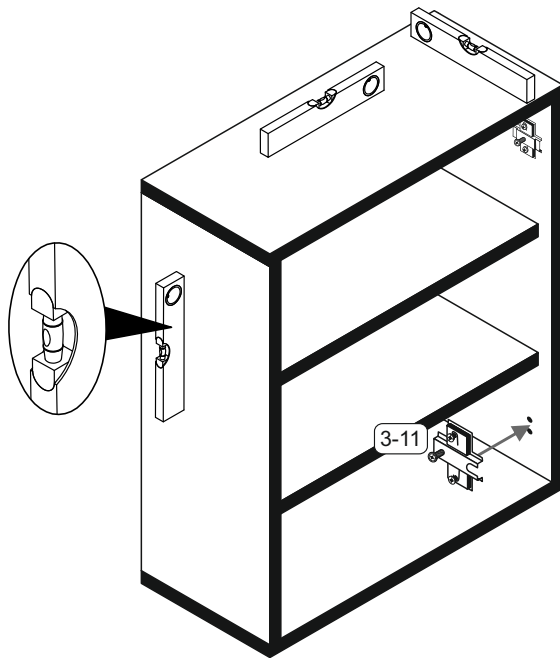
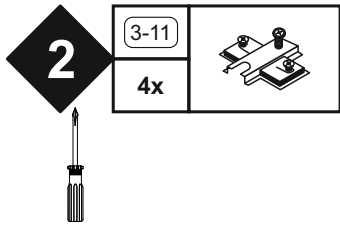

Montage der Tüрдämpfung

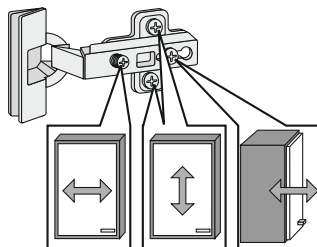
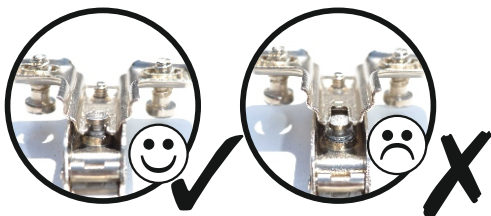
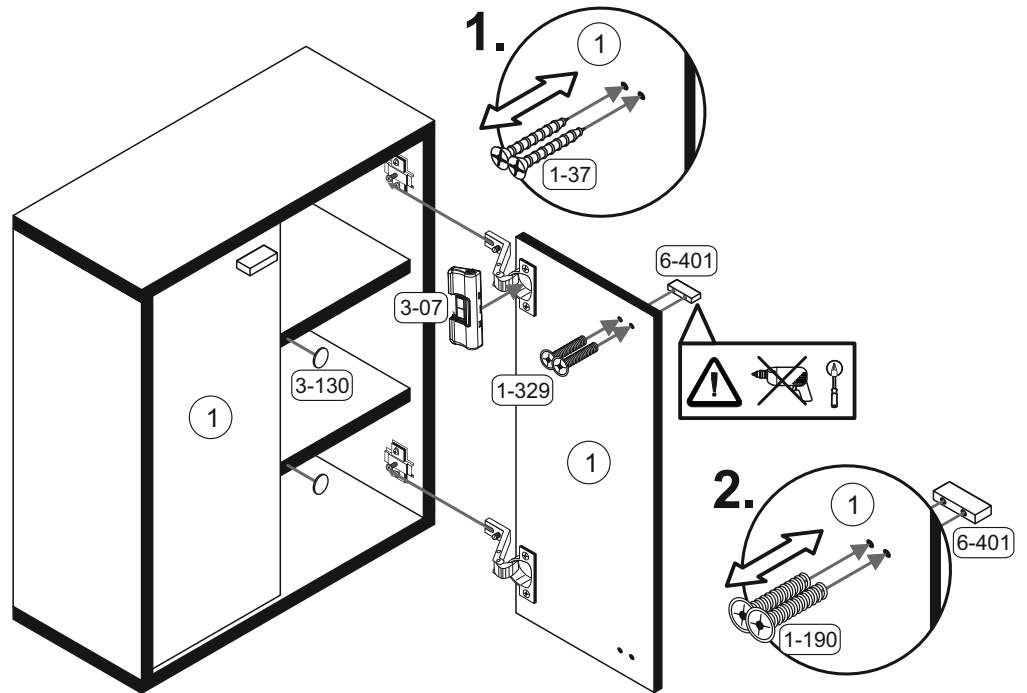
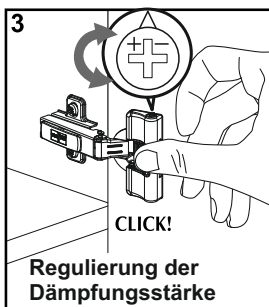
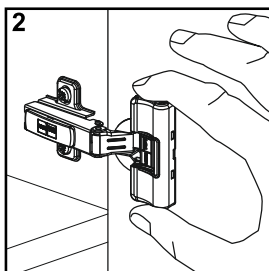
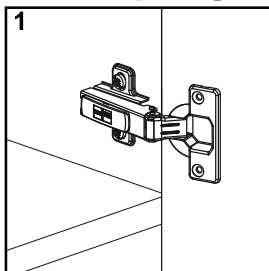

- Türen einstellen (Scharniere justieren)
- Adjusting the doors (adjusting the hinges)
- Régler les portes (ajuster les charnières)
- Sistemare le porte (regolare le cerniere)
- Deuren instellen (scharnieren afstellen)
- Nastawić drzwi (wyregulować zawiasy)
- Vyrovnejte dvířka (seřid'te závěsy)
- Nastavenie dverí (nastavenie závesov)
- Állítsa be az ajtókat (állítsa be a zsanérokot)
- Reglare uși (ajustare balamale)
- Kapların ayarlanması (menteselerin seviye ayarı)
- Регулировка дверей (регулировка шарнира)