

A	B	C (mm)			D
1	L96-0005	2110	496	22	6/7
2	L96-0006	2110	496	22	6/7
3	L96-0007	2110	496	22	6/7
4	L96-0008	2110	496	22	7/7
5	L96-1006	2180	560	15	1/7
6	L96-1007	2180	560	15	1/7
7	L96-1008	2180	560	18	2/7
8	L96-1009	2180	560	18	2/7
9	L96-3005	482	560	15	3/7
10	L96-3006	976	560	15	3/7
11	L96-3007	482	560	15	3/7
12	L96-3008	976	560	15	3/7
13	L96-3009	482	539	22	4/7
14	L96-3010	976	539	22	4/7
15	L96-4002	976	65	15	3/7
16	L96-4003	482	65	15	3/7
17	L96-5007	1278	70	68	5/7
18	L96-5008	1278	70	68	5/7
19	L96-5009	604	70	68	5/7
20	L96-5010	604	70	68	5/7
21	L96-9006	2095	490	2,5	7/7
22	L96-9301	2095	986	2,5	7/7
23	dr-972	972	30	15	3/7

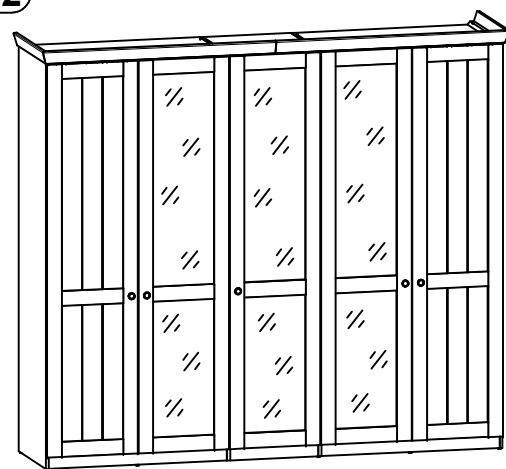

cm

8x  a158	12x  a159	20x  b78	5x  c509	0 1 2 3 4 5 6 7 8 9 10
18x  d20	24x  d28	12x  e1	40x  e2	
4x  n158	1x  n3	2x  n110	4x  p1	
36x  r54	12x  s1	1x  s9317	1x  z1	
			24x  e50	
			18x  e50	
			12x  e51	
			12x  f1	
			8x  l63	
			12x  k1	
			36x  r37	
			2x  n142	
			4x  p38	
			2x  f35	
			2x  p17	

1 §2

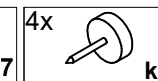
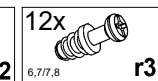
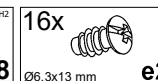
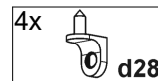
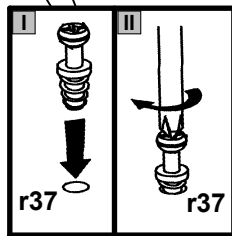
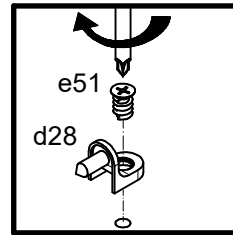
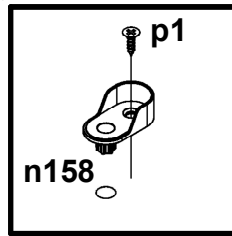
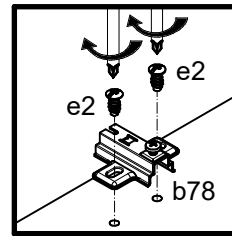
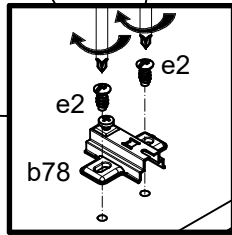
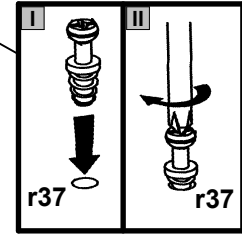
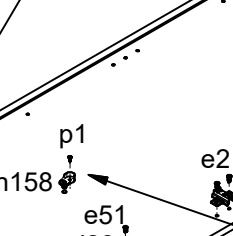
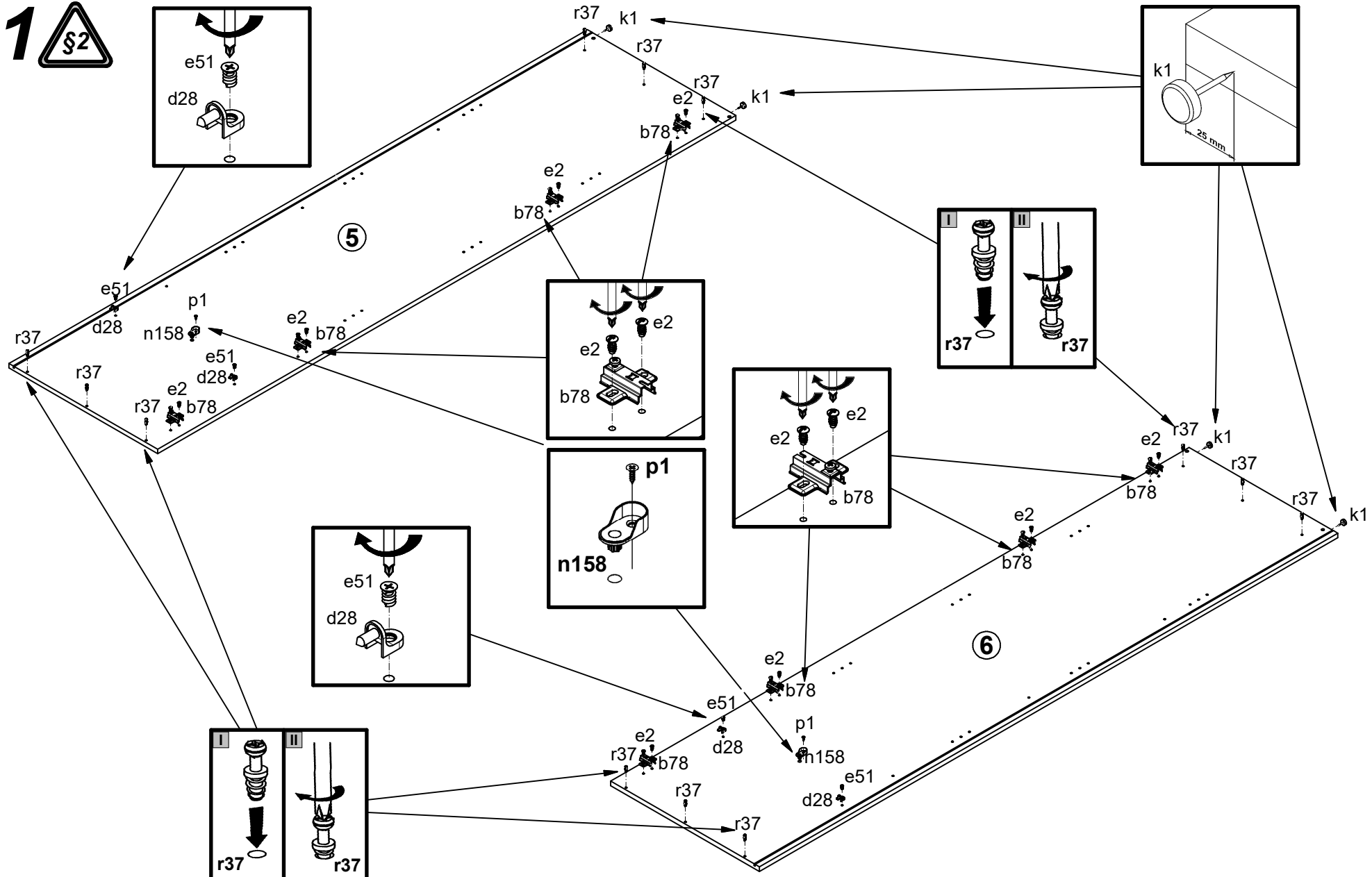
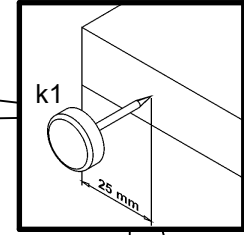
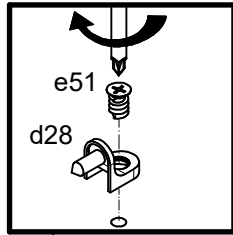



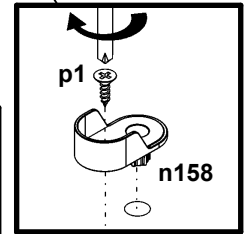
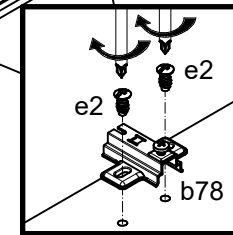
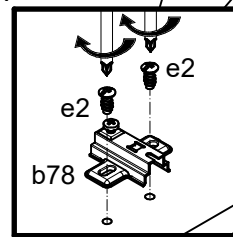
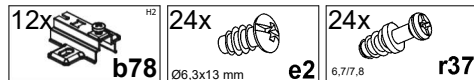
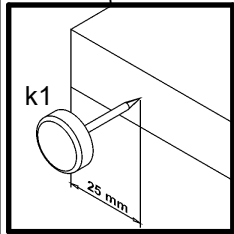
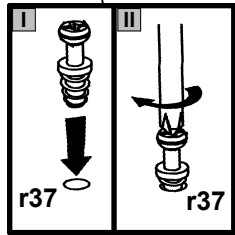
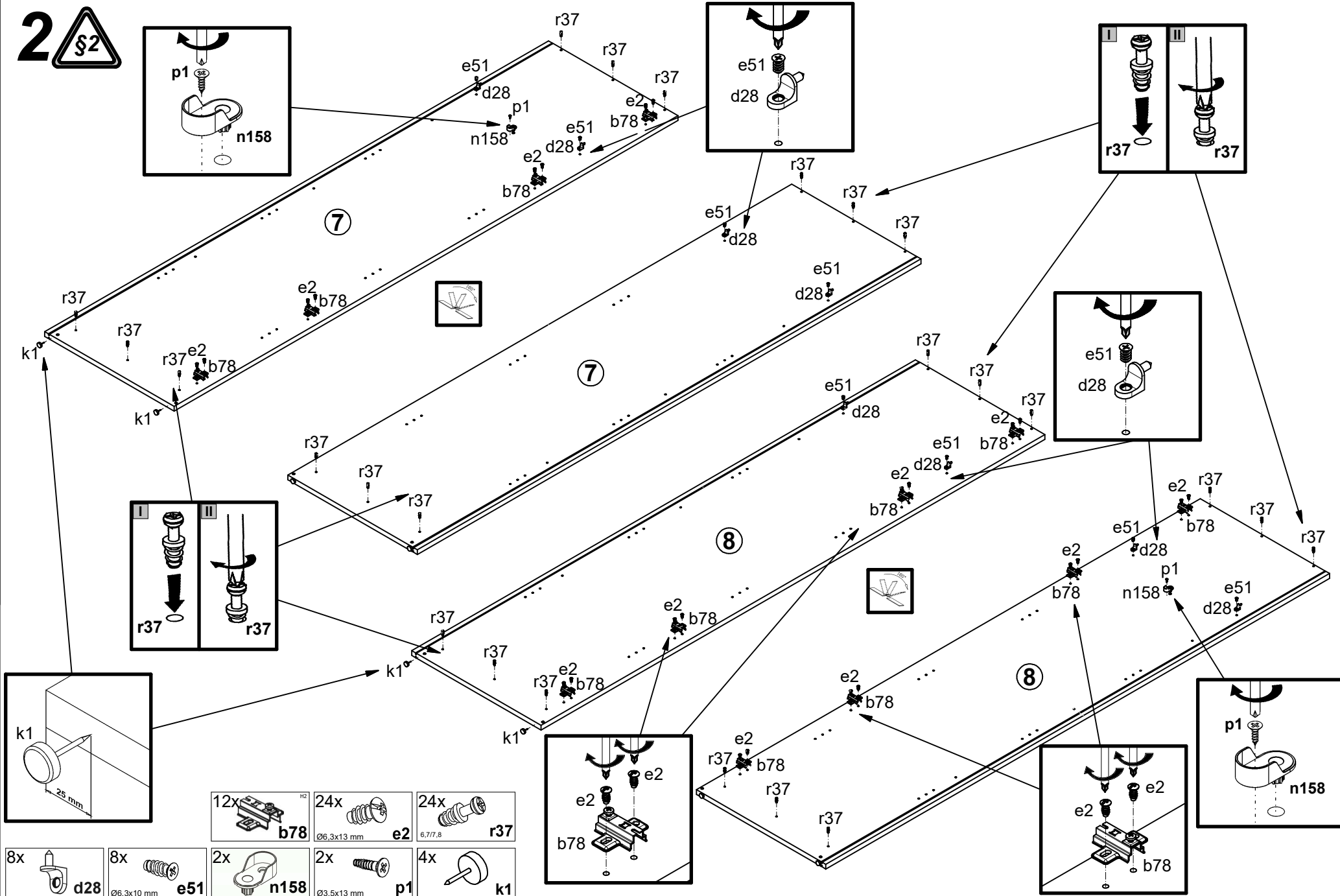
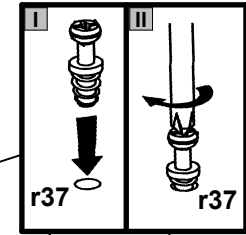
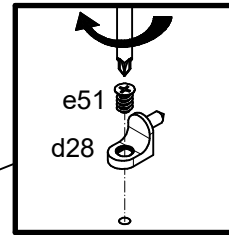
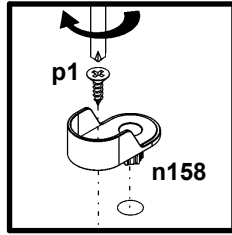

2 

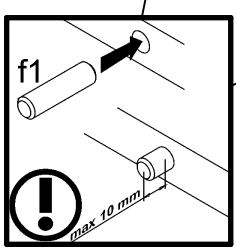
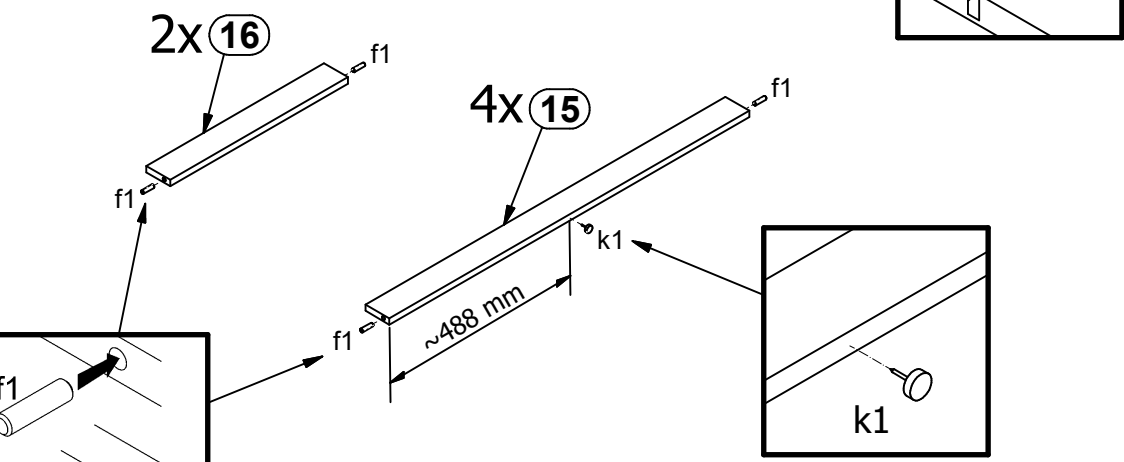
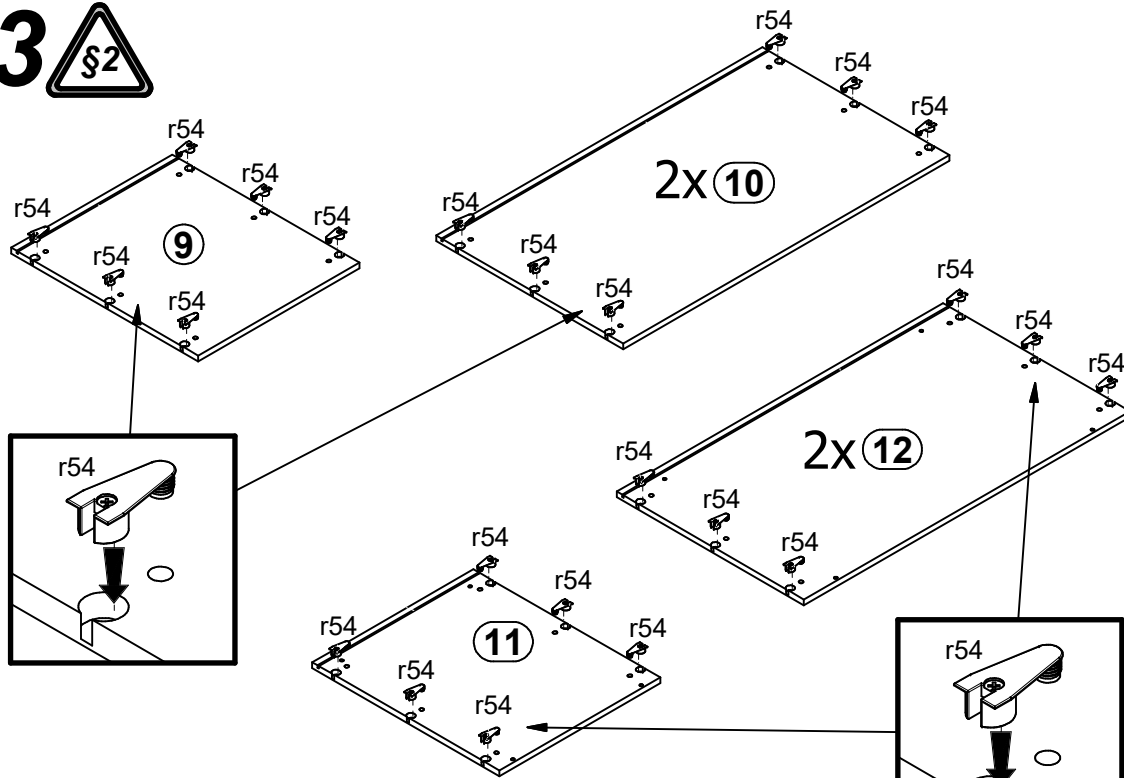

- 8x  d28
- 8x  e51
- 2x  n158
- 2x  p1
- 4x  k1
- 12x  b78
- 24x  e2
- 24x  r37

3 §2



- 36x  #19  
Ø20x13,5 mm r54
- 12x  f1  
Ø8x30 mm
- 4x  k1

4 §6

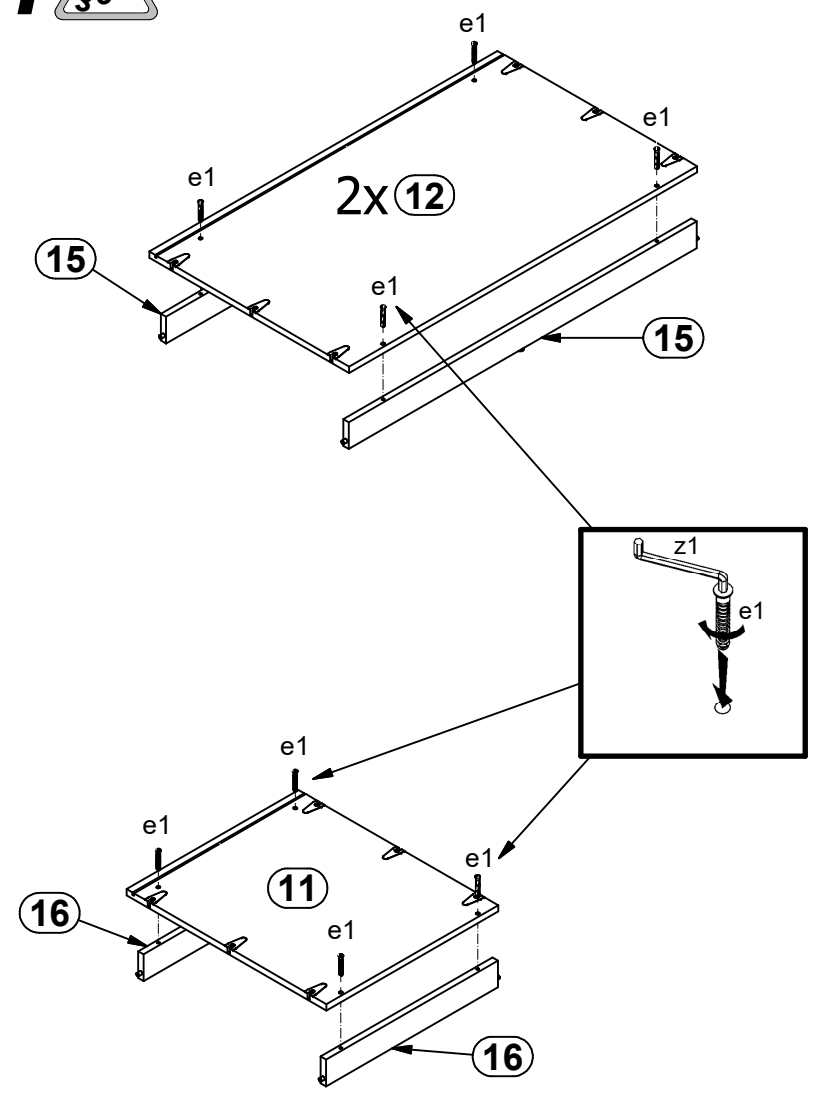

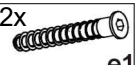
- 12x  e1  
Ø7x50 mm

**5** §6

I

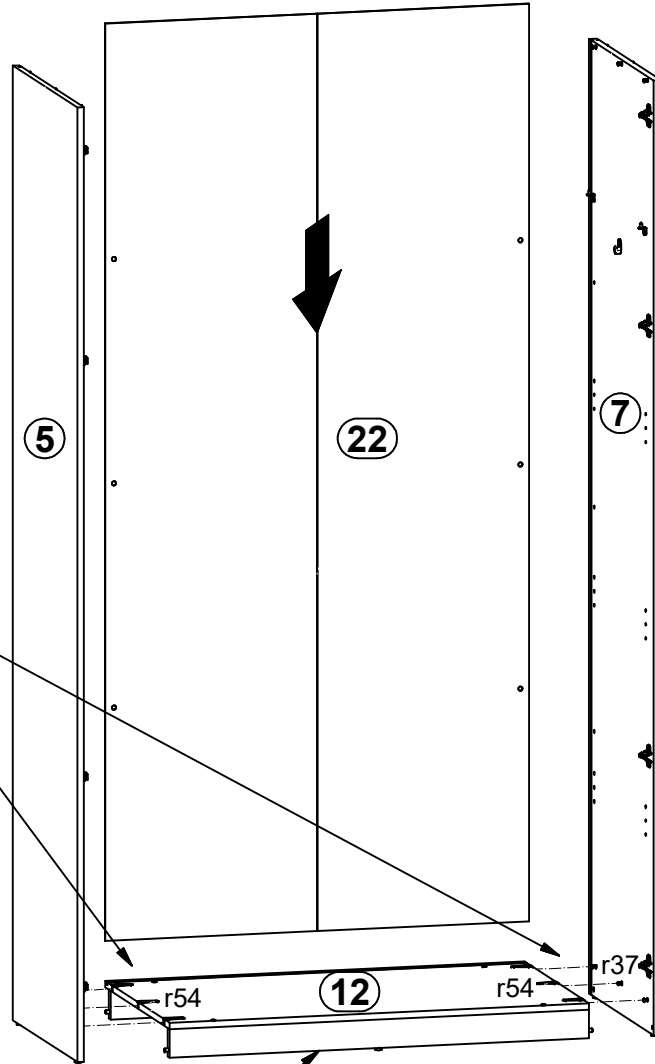

II

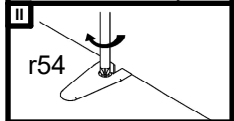
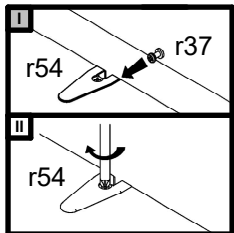
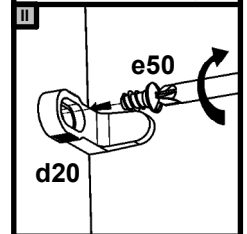
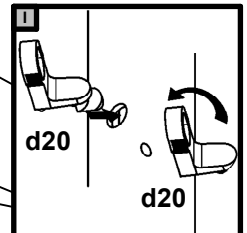
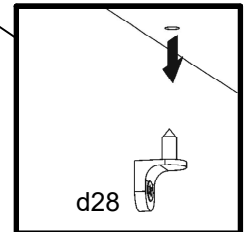
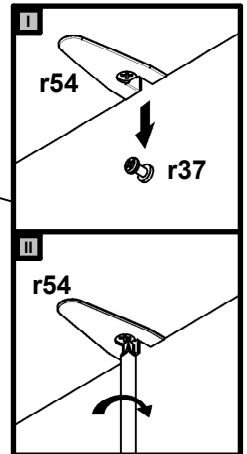
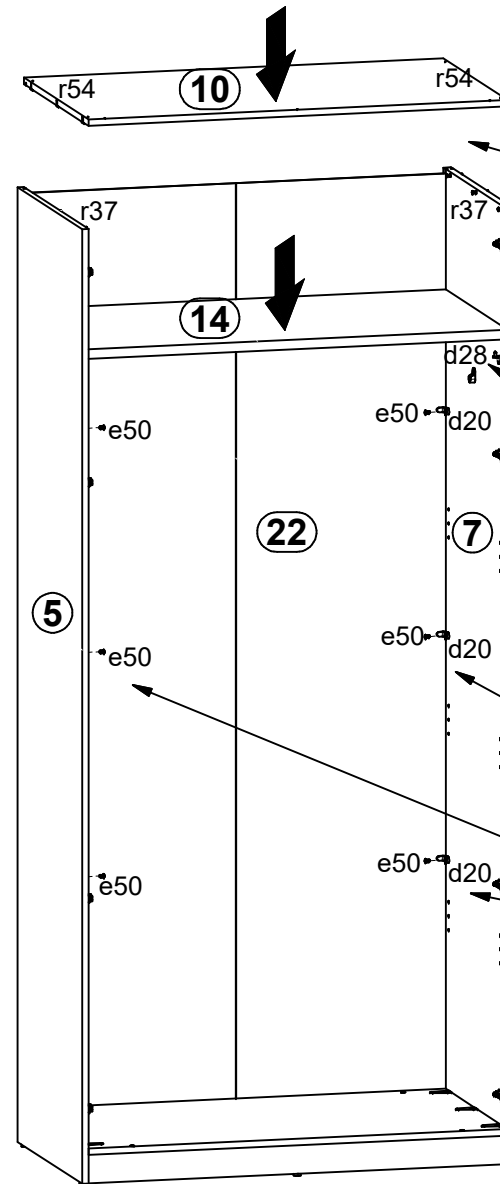

- 6x d20
- 6x Ø6.3x10 mm e50

**6** §6

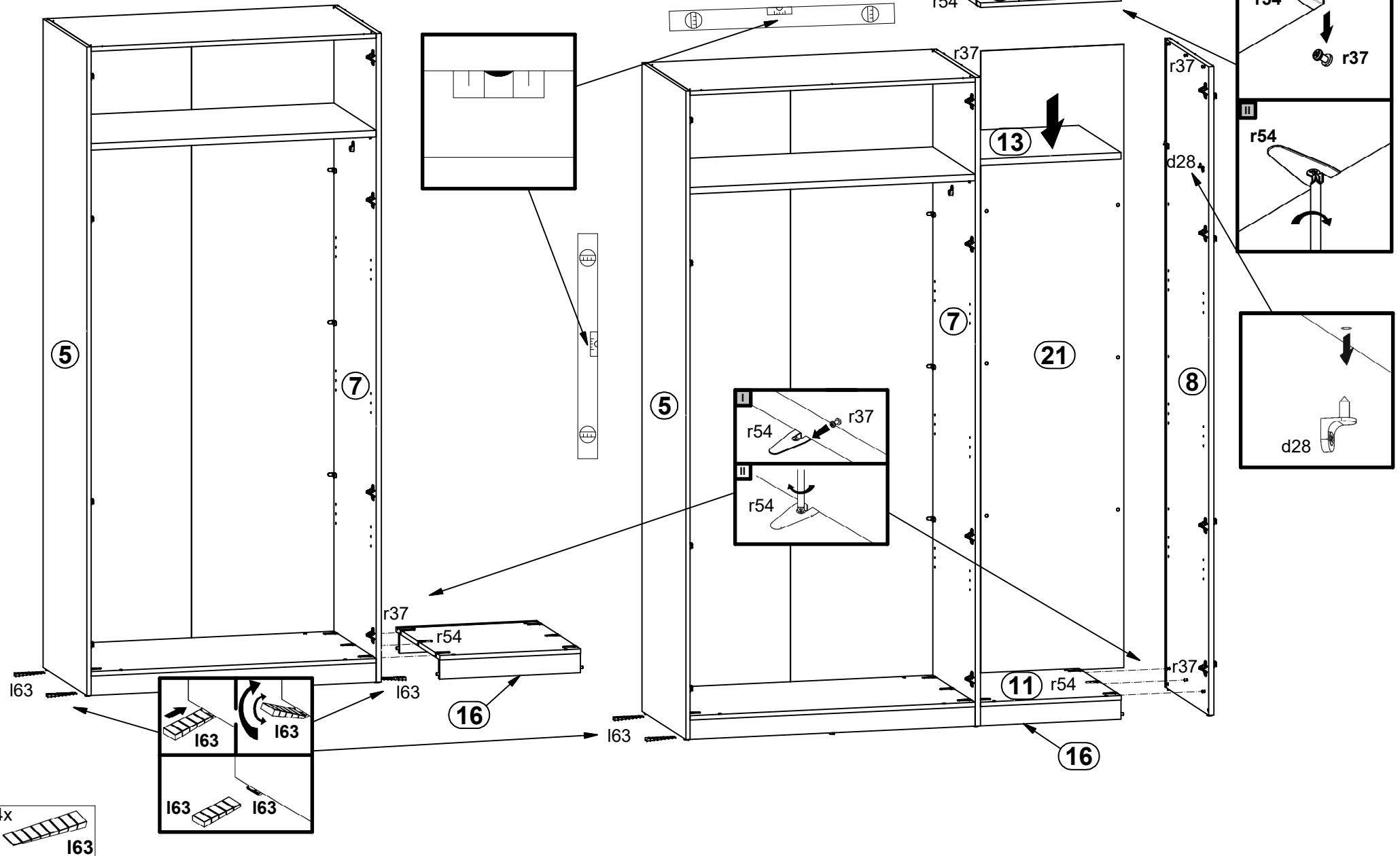

**I**

**II**

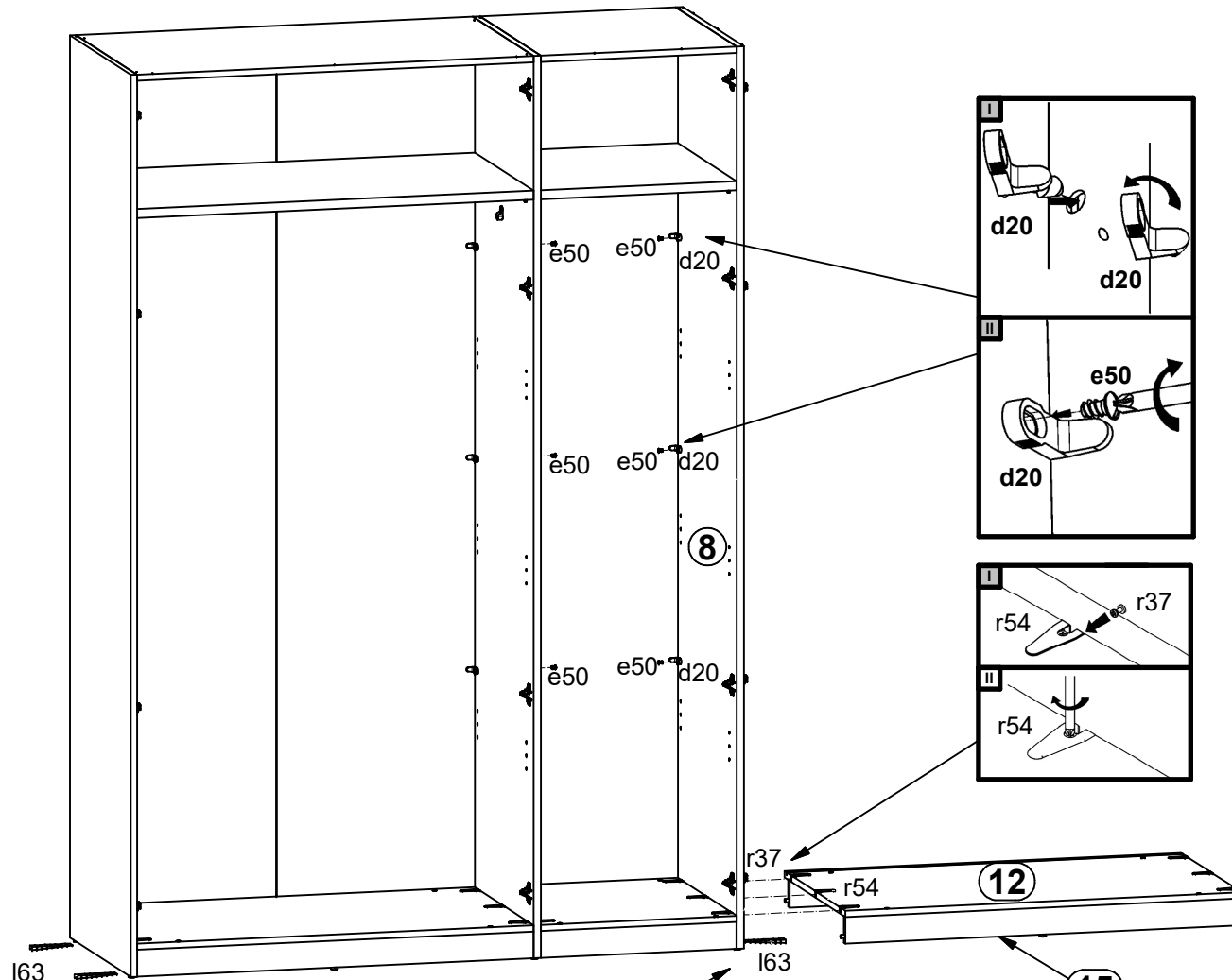

7 



- 6x  d20
- 6x  e50 Ø6.3x10 mm
- 4x  163

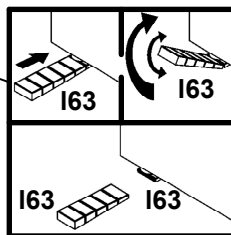



8 §6

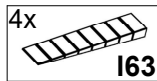
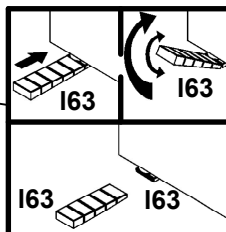
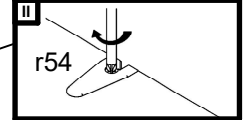
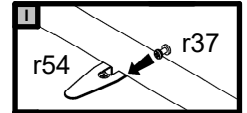
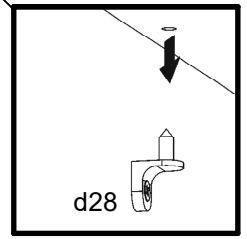
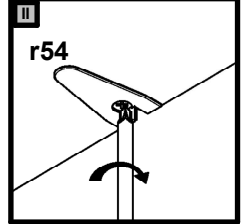
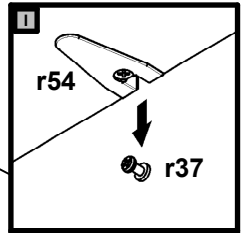
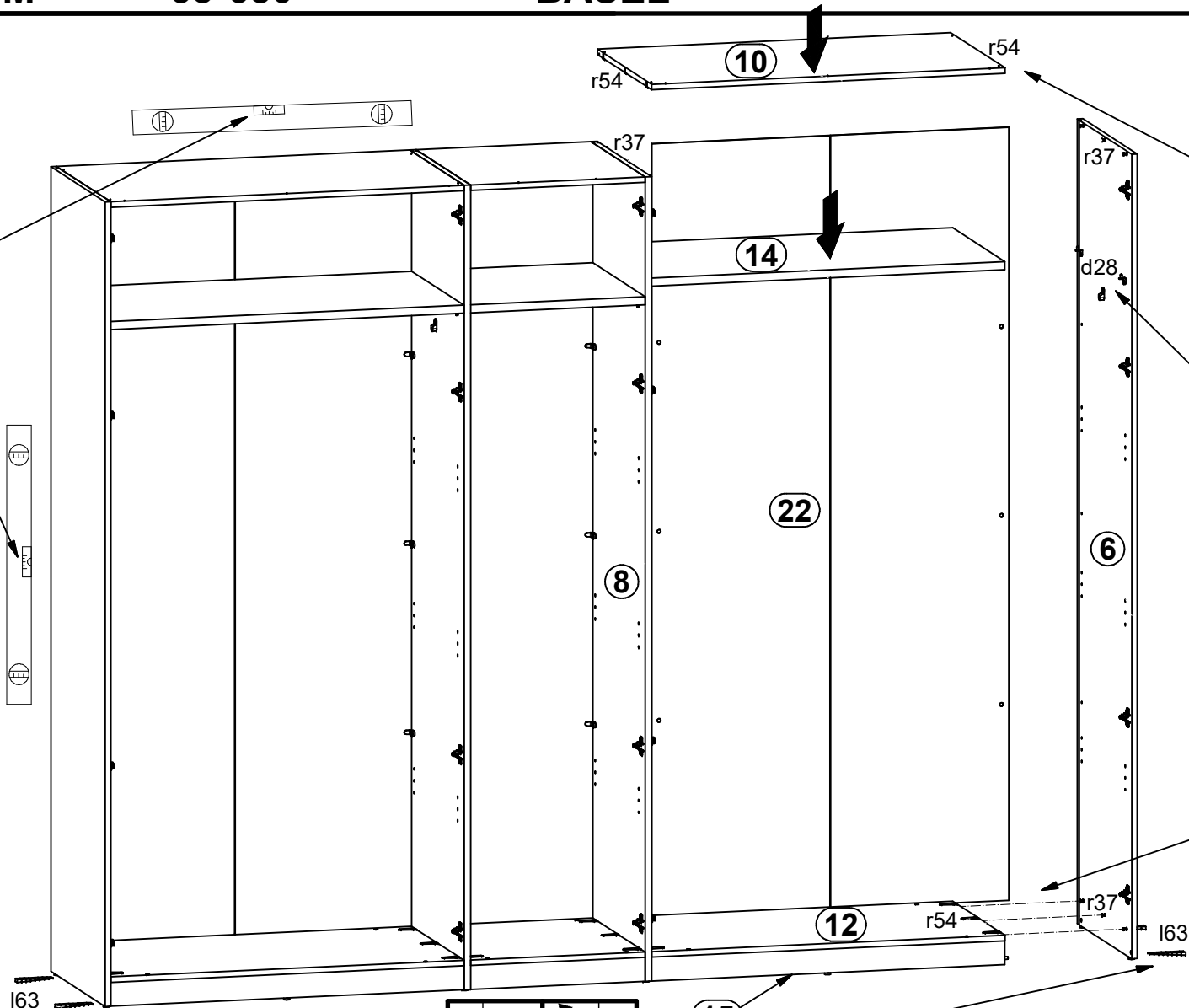
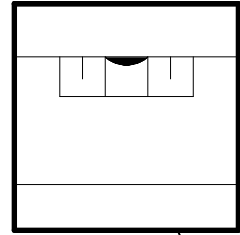

9 

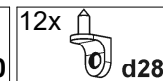
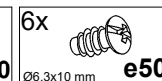
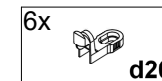
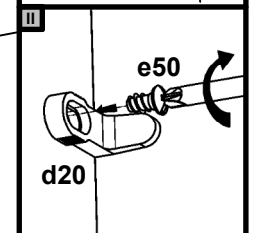
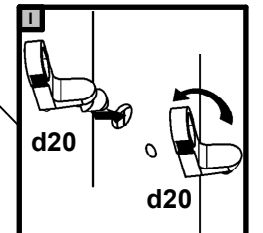
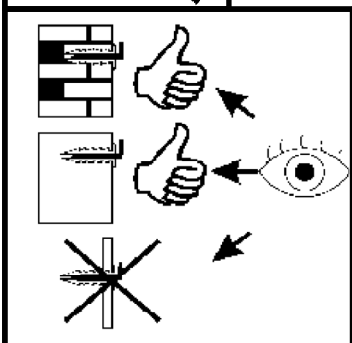
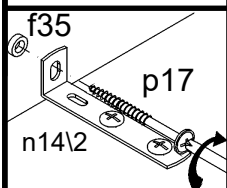
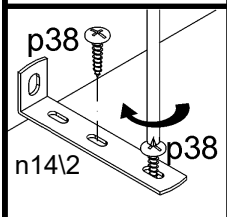
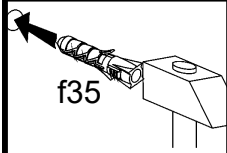
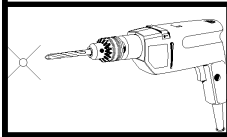
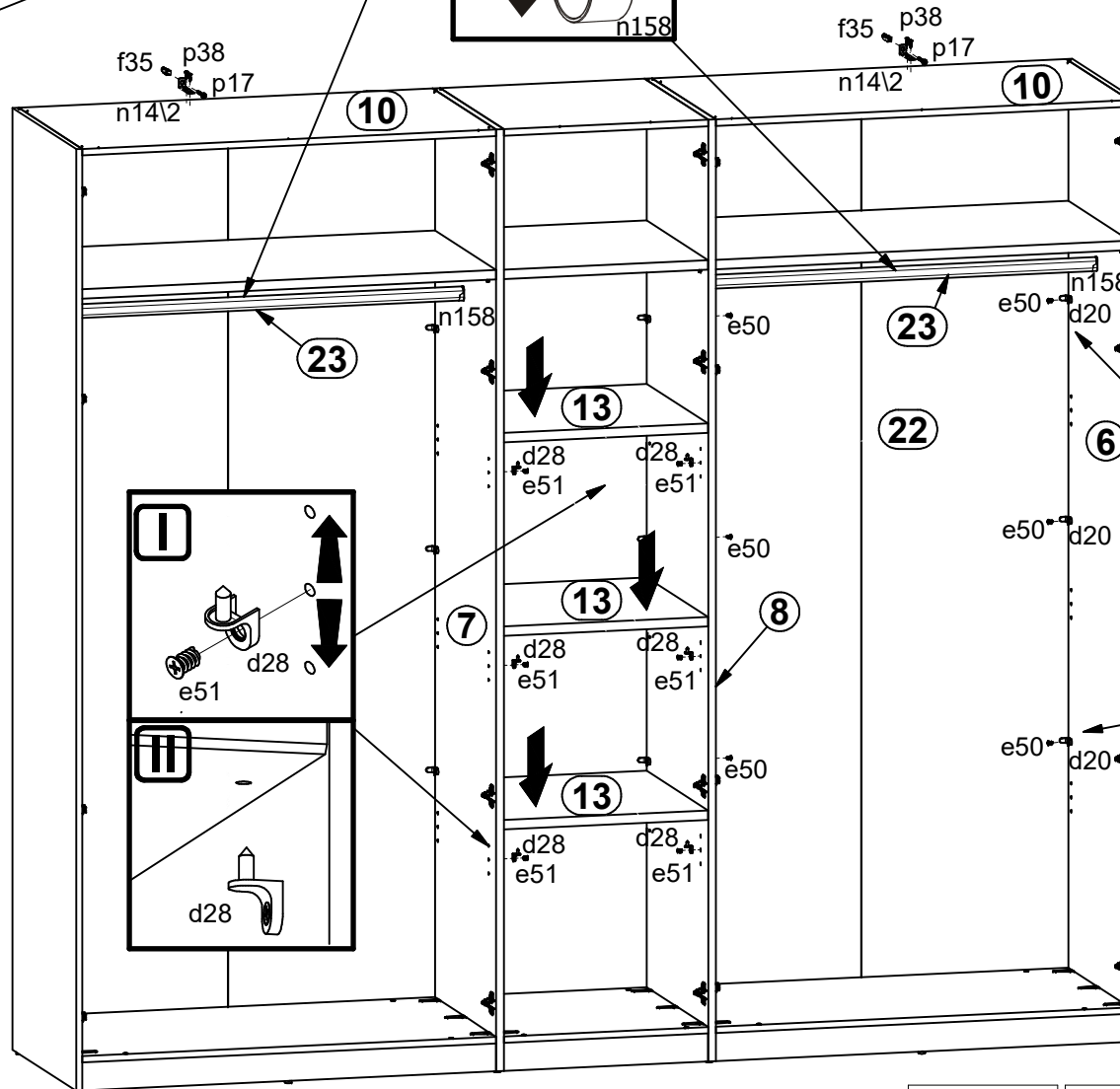
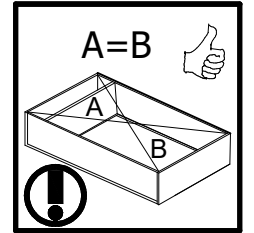
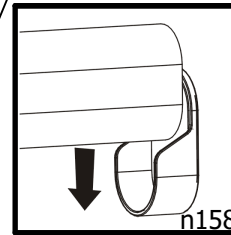
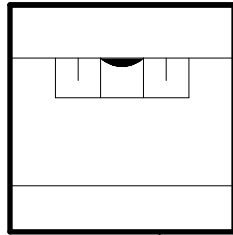
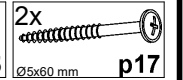
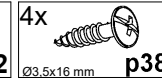
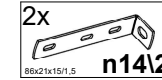

**10** §6

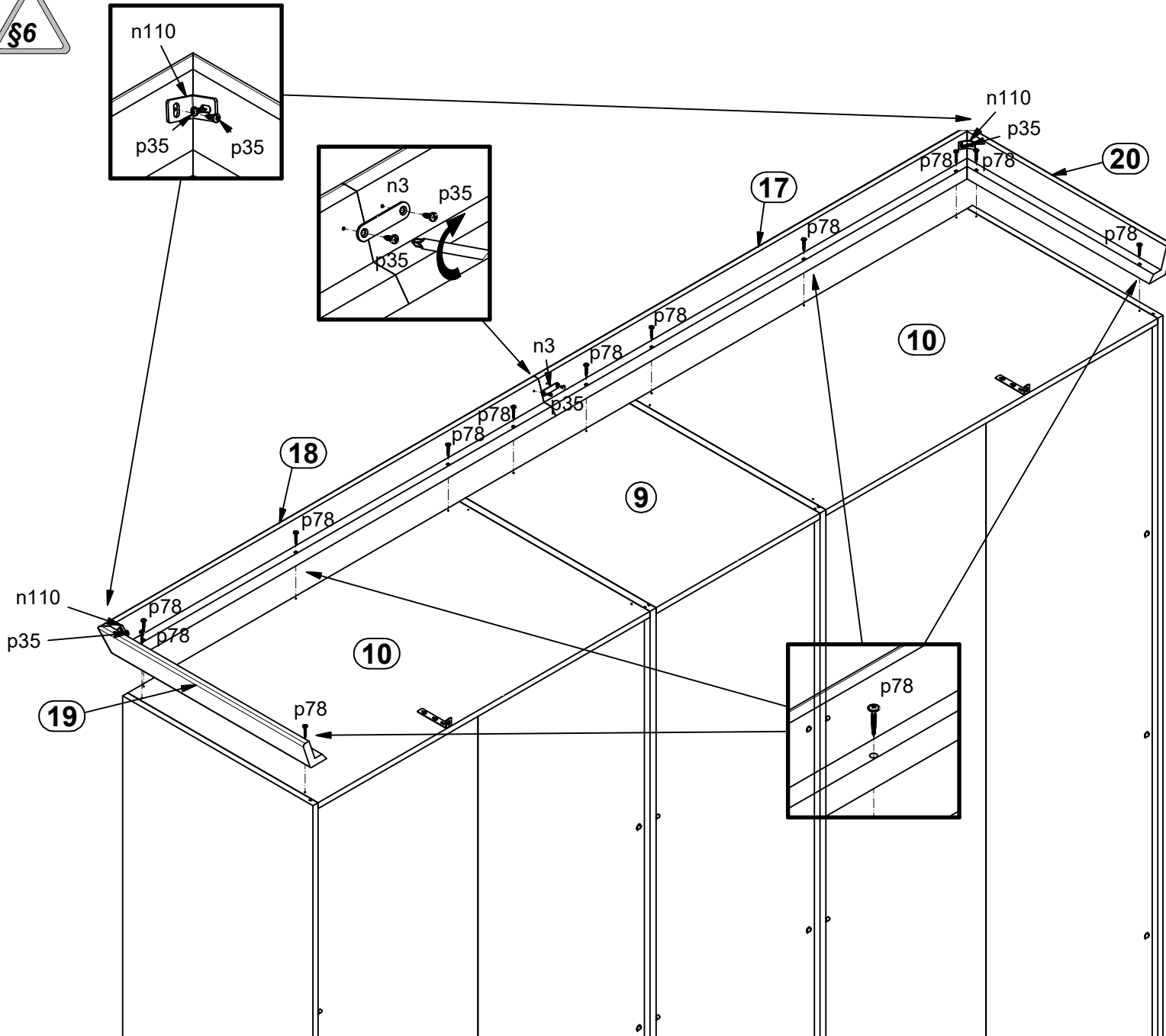

1x 50x12x1,5 mm		6x Ø3,5x10 mm	
2x 25x25x16x1,5 mm		12x Ø3,5x30 mm	

# 11

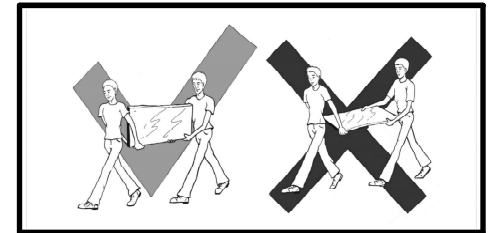
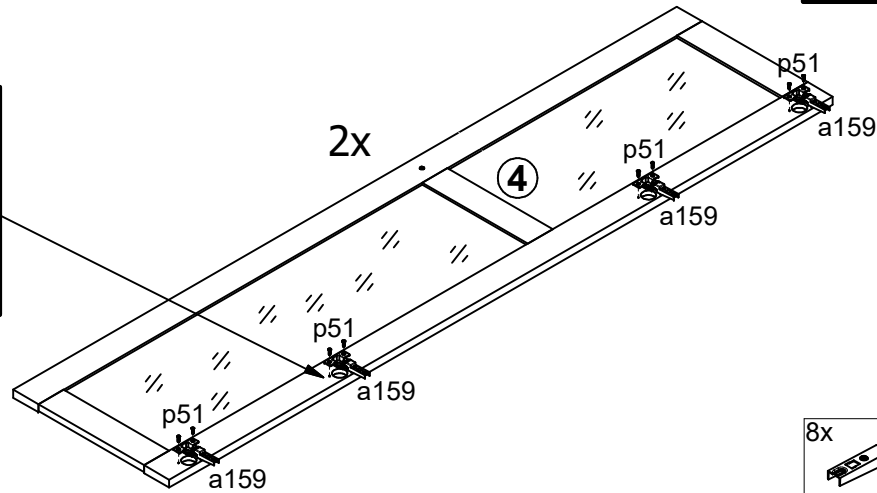
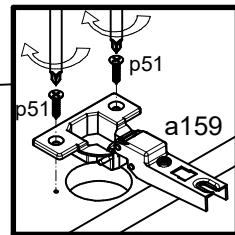
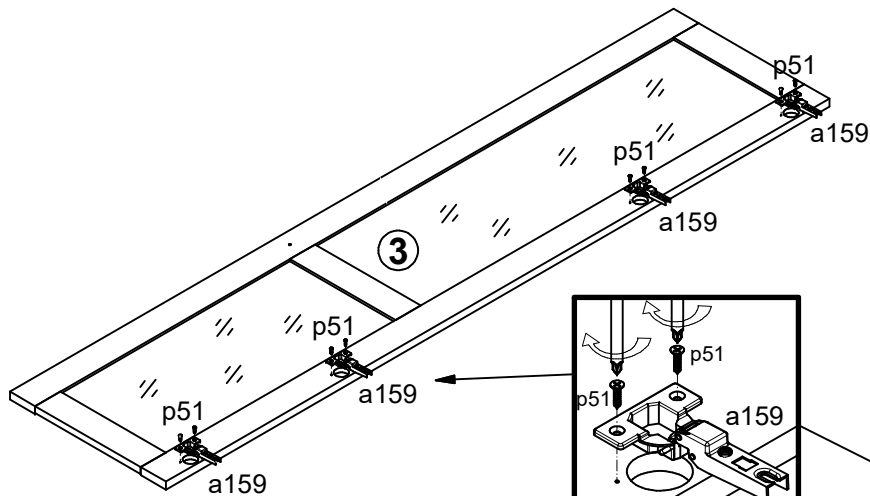
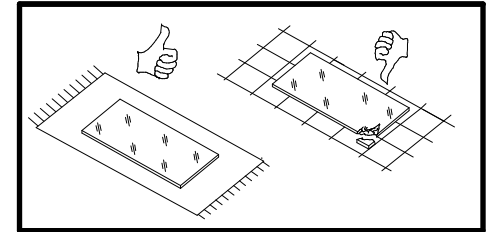
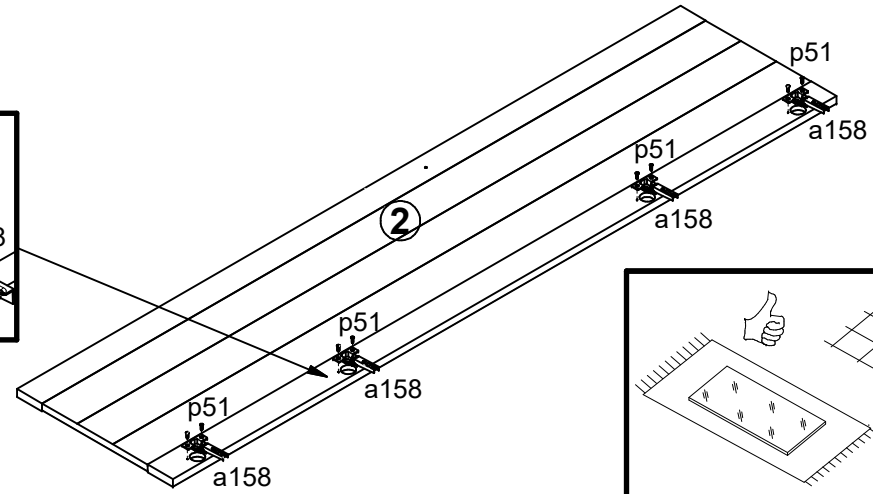
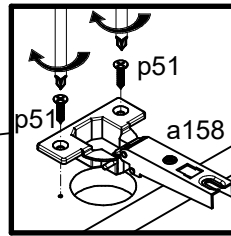
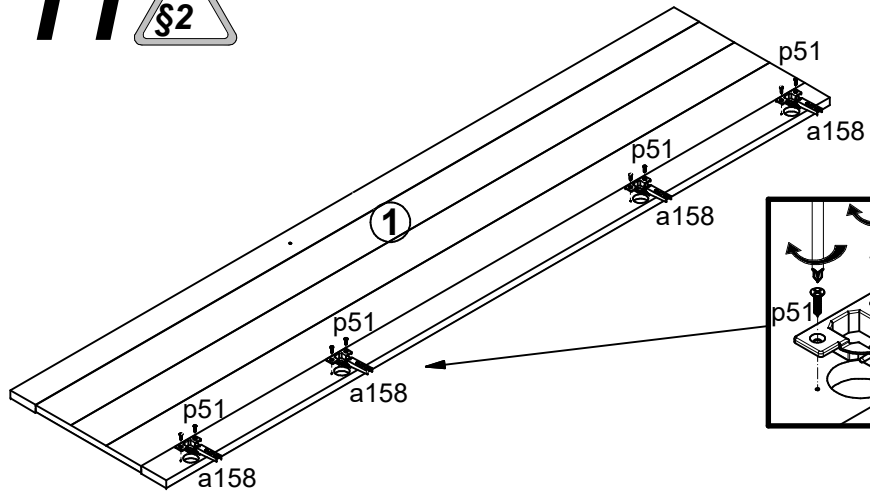

12 §6 §11

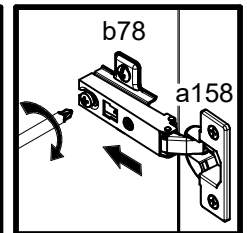
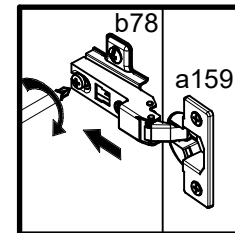
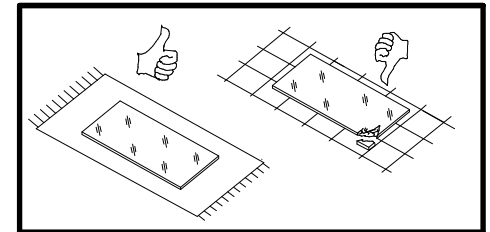
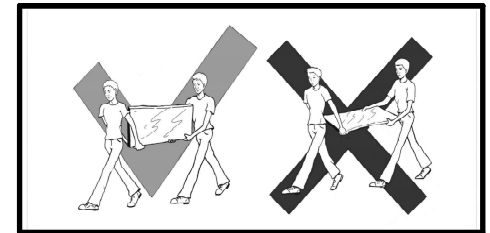
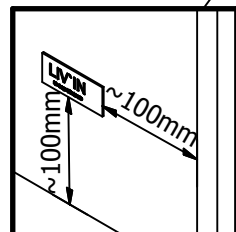
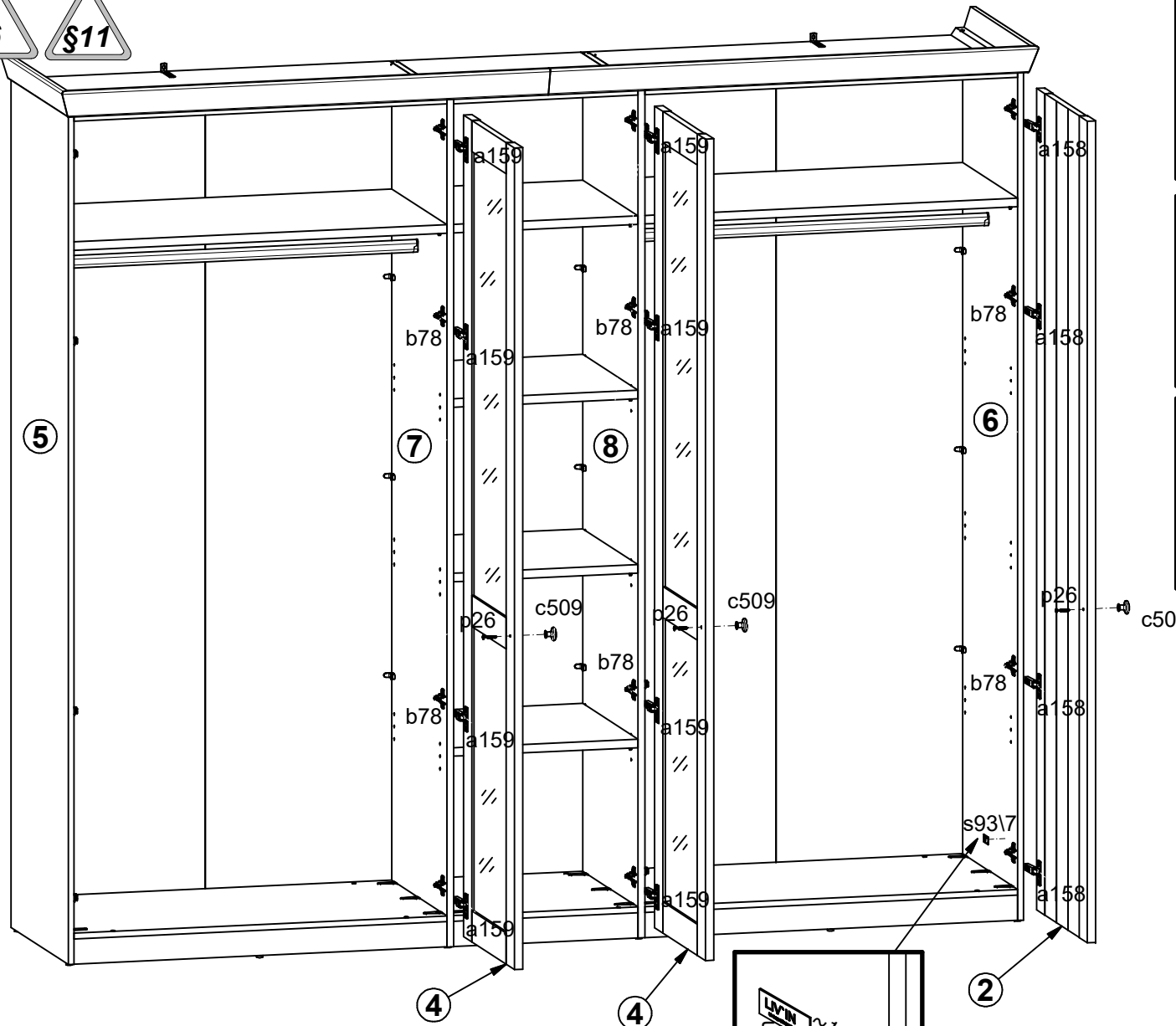

- 1x LVIN naklejka s93\7
- 3x M4 c509
- 3x Ø4x35 mm p26

13 §6 §11

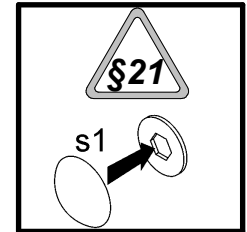
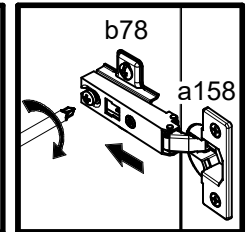
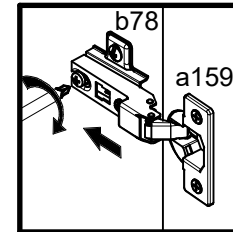
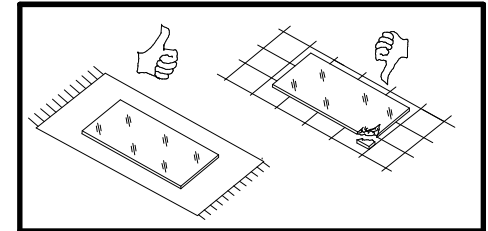
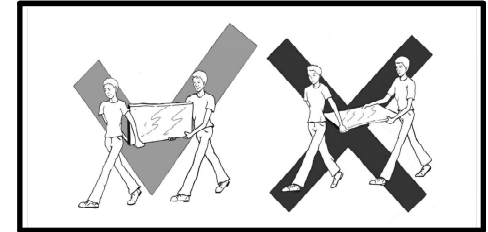
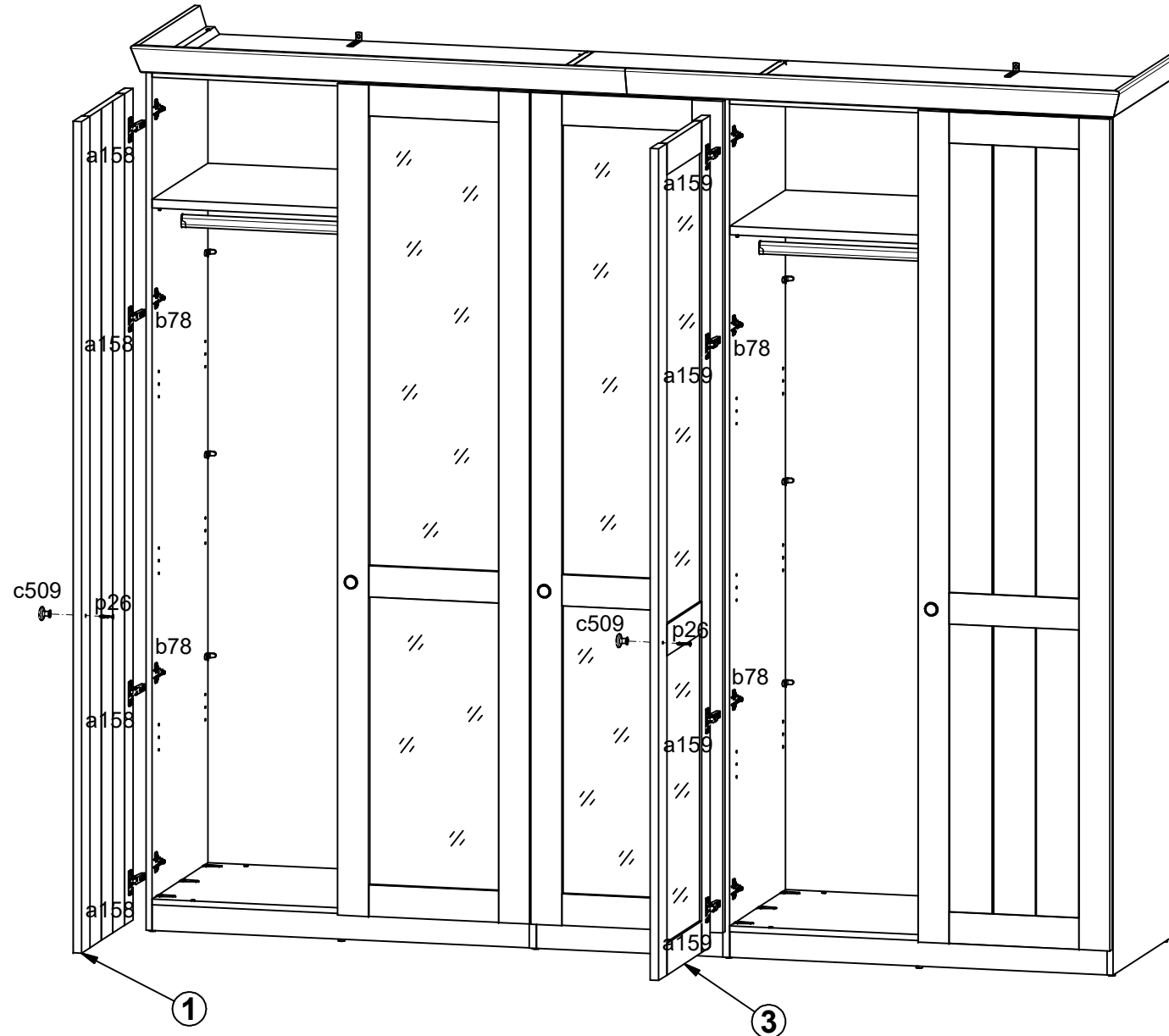

# 14

