

Benötigte Werkzeuge – Outils Nécessaires – Tools Required – Attrezzi Necessari

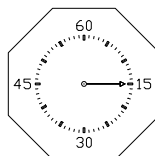

A x3

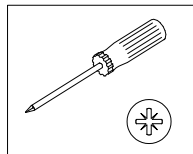

B x1

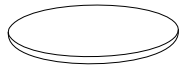

C x6

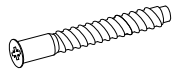

631.80500

D x3

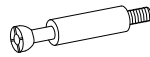

629.00002

E x3



629.00001

1.

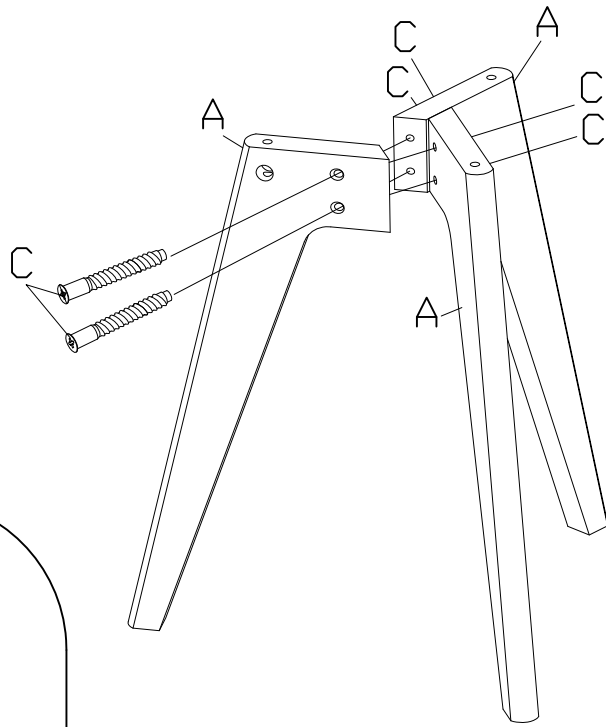

2.

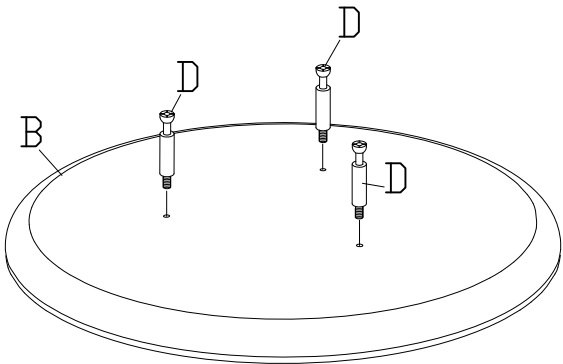

3.

