

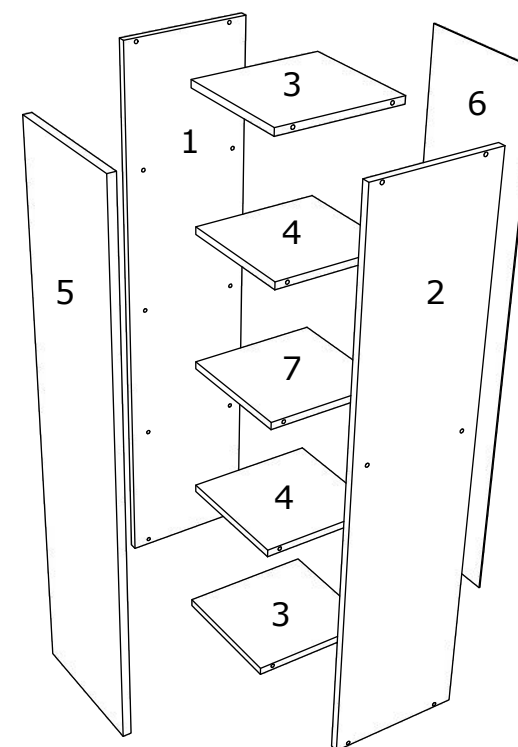

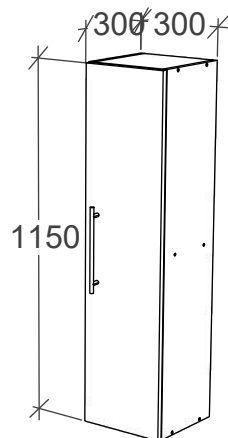







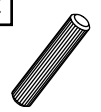

VCM.
my home

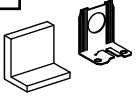
service@vcm-gruppe.de

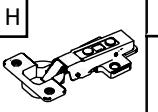
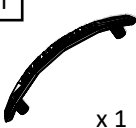
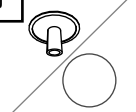
Aufbauanleitung

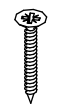
Artikel: **SCHRANK ARILA L**
300 x 300 x 1150 mm



A	7x50mm  x 12	B	 x30	C	 x 8	D	4 x 22mm  x 2	E	 x 2	F	6x80mm  x 2
G	 x 2	H	 x 2	I	320 mm  x 1	J	 x 12	K	 x 1	L	3.5 x 16 mm  x 22
M	 x 2	N	 x 2	O	 x 2						

No	B	b	x
1	1150	280	1
2	1150	280	1
3	268	280	2
4	268	268	2
5	1146	296	1
6	1146	296	1
7	268	268	1

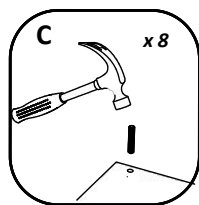
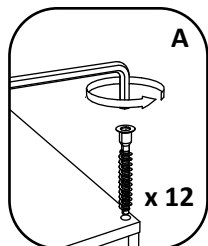
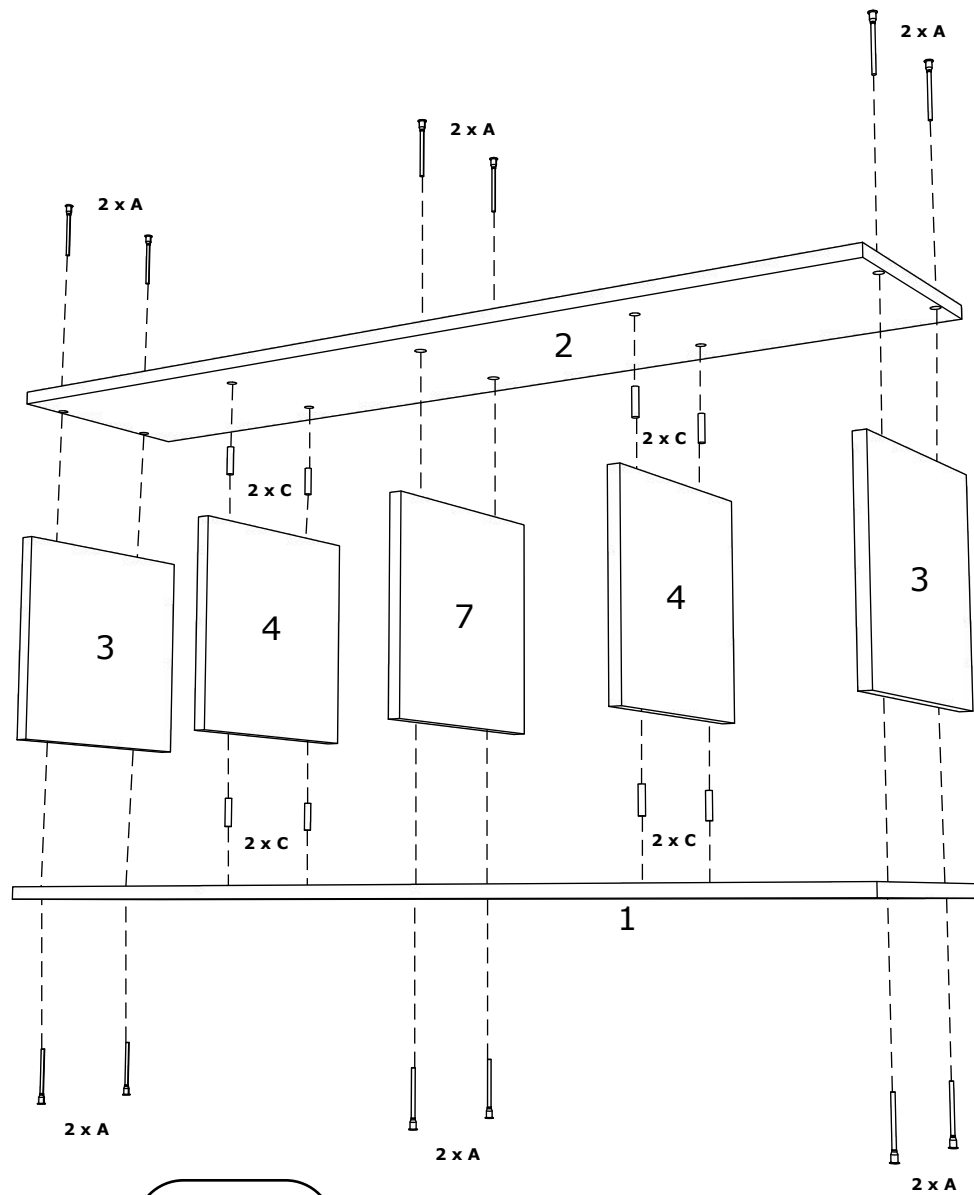

1

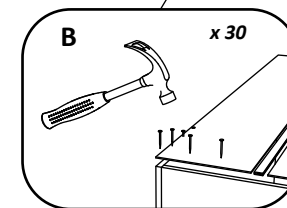
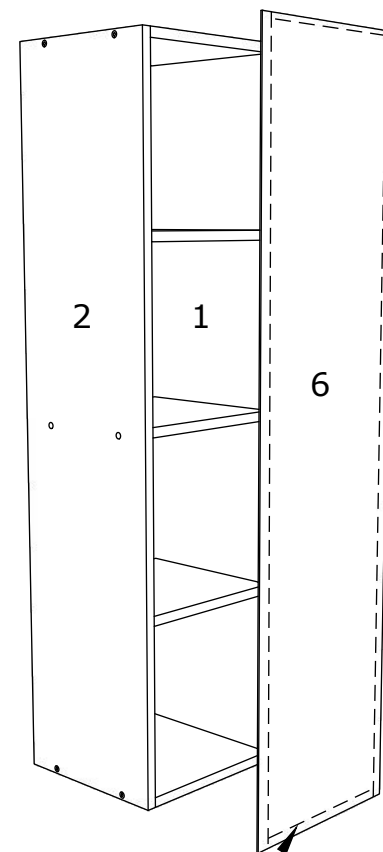

2

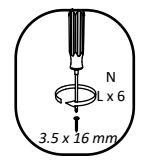
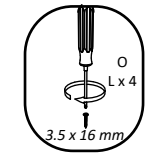
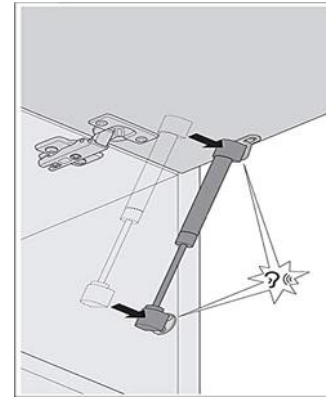
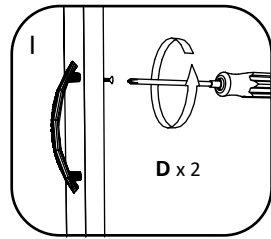
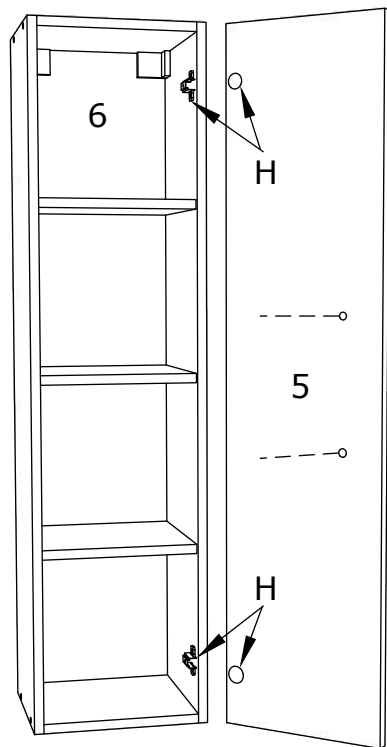
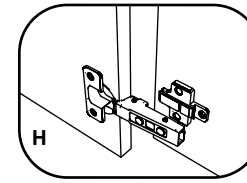
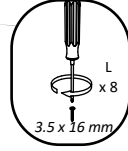
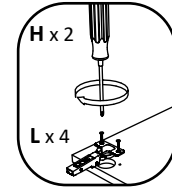
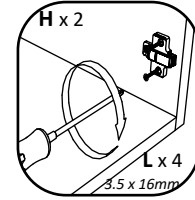
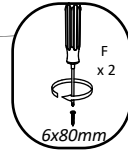
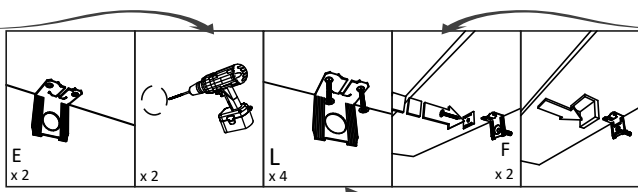

OR

