

ASSEMBLY INSTRUCTIONS

ITEM NO.: 25558

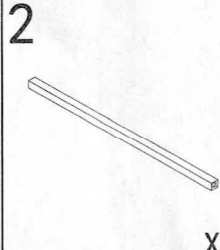

X1



X1

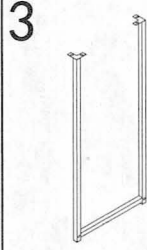

X2

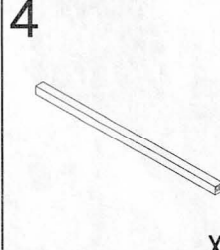

X2

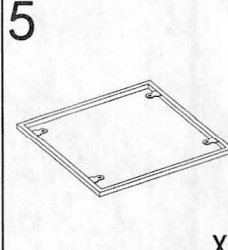

X1

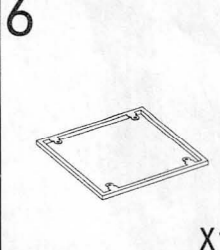

X1

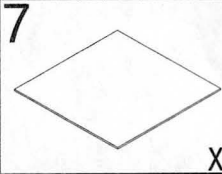

X1

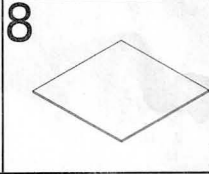

X1

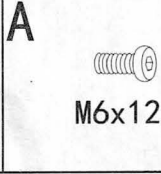

X16

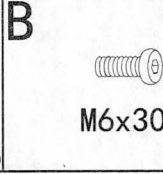

X6

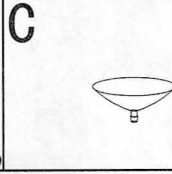

X8

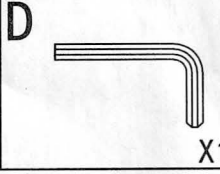

X1

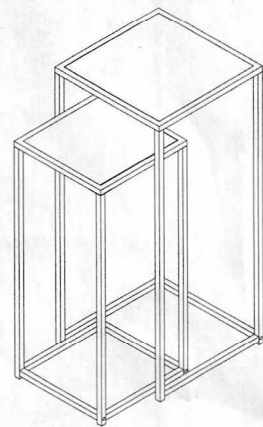
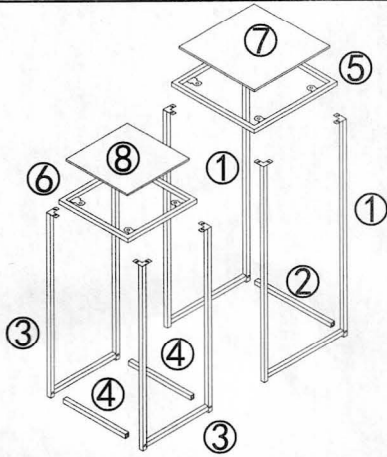

STEP 1:

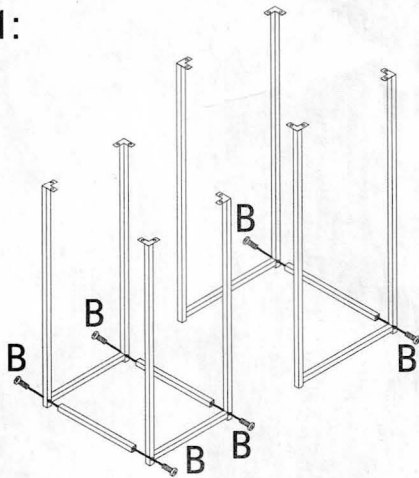

STEP 2:

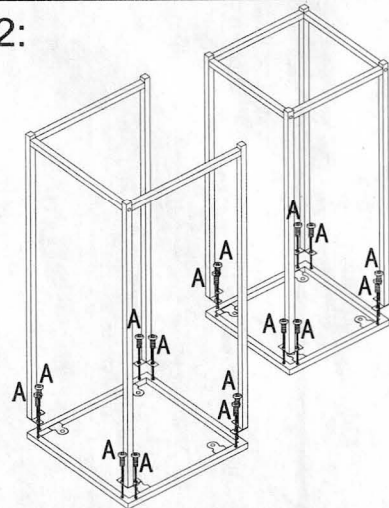

STEP 3:

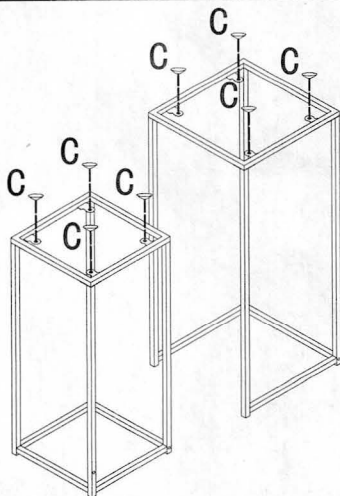

STEP 4:

