

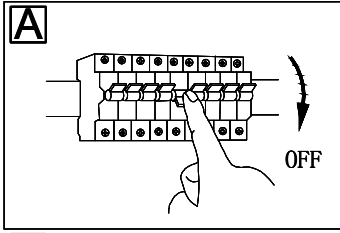









# GLOBO

## LIGHTING

41314-28

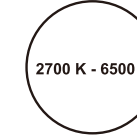

**B**

-  incl.
-  many light steps
-  dimmable
-  3 LIGHT STEPS  
4000 K 6500 K 2700 K
-  many light steps
-  many steps
-  colour fixing
-  2700 K - 6500 K
-  night light

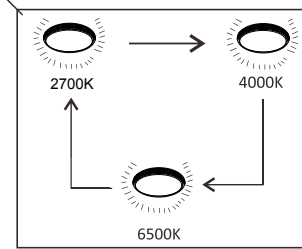
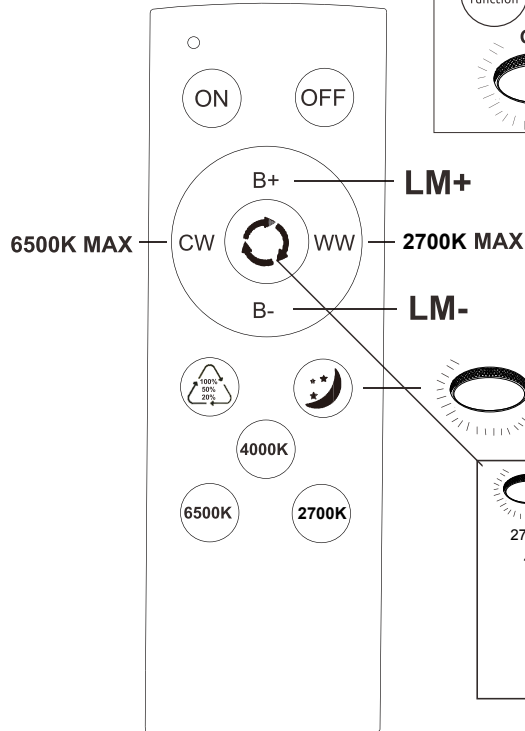
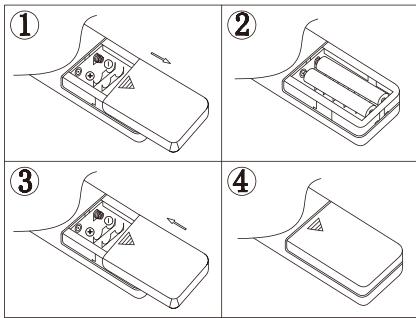
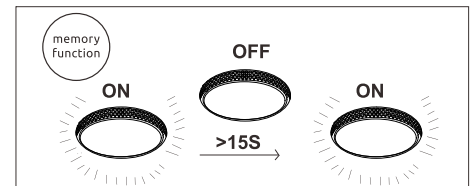
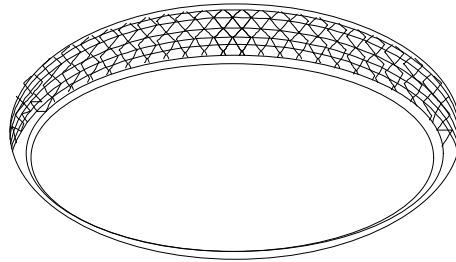
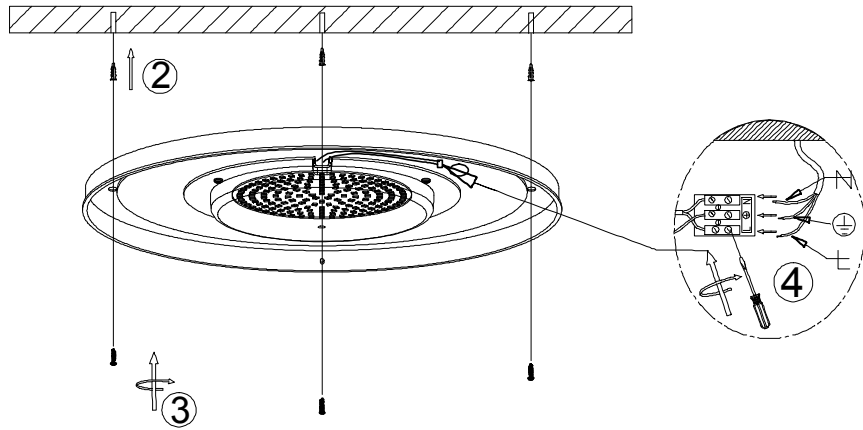

**BATTERY DATA**  
 2x AAA battery\* incl.  
 \*Manufacturer: Ningbo GP & Sonluk Battery Co., Ltd  
 Address: No.600 Qingfeng Road, Cicheng Town  
 Jiangbei District, Ningbo, Zhejiang, China  
 Model: R03, 1.5V

**SAFETY INSTRUCTIONS**

1x MAX 28W LED  
 220-240V~ 50/60Hz

GLOBO Handels GmbH  
 Gewerbstrasse 3  
 A-9184 Sankt Peter, Austria  
[www.globo-lighting.com](http://www.globo-lighting.com)  
[office@globo-lighting.com](mailto:office@globo-lighting.com)

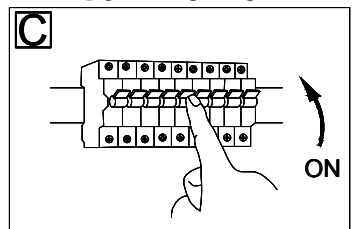
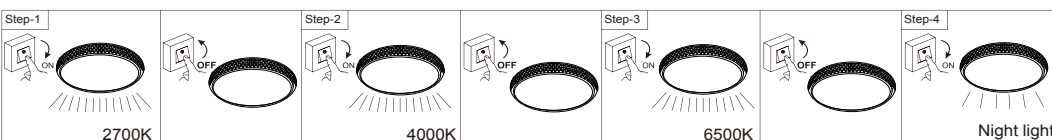

## Lichtquelle:

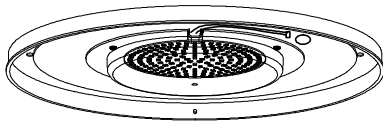

### DEU:

#### Lichtquelle:

Die Lichtquelle ist nicht tauschbar, weil sie konstruktionsbedingt fest mit dem umgebenden Produkt verbunden ist.

Dieses Produkt enthält eine Lichtquelle der Energieeffizienzklasse <E>.



   Die LED - Lichtquelle ist nicht austauschbar.

### GBR:

#### Light source:

The light source is not interchangeable because it is determined by the surrounding product design.



This product contains a light source of energy efficiency class <E>.

   The LED - light source cannot be replaced.

### BG:

#### Източник на светлина:

Източникът на светлина не може да се подменя, тъй като поради конструкцията си е трайно фиксиран към заобикалящия го продукт. Този продукт включва светлинен източник с клас на енергийна ефективност <E>.

   LED източникът на светлина не може да се подменя.

### BIH:

#### Izvor svjetla :

Izvor svjetla nije zamjenjiv , jer je konstrukcijski pričvršćen na proizvod.

Ovaj proizvod sadržava izvor svjetlosti klase energetske učinkovitosti <E>.



   LED – izvor svjetla nije moguće zamjeniti

### FR:

#### Source lumineuse:

La source lumineuse n'est pas remplaçable car elle est, de par la construction du produit, liée de façon permanente à celui-ci.

Ce produit contient une source lumineuse de classe d'efficacité énergétique <E>.

   La source lumineuse LED n'est pas remplaçable.

### GR:

#### Φωτεινή πηγή:

Η φωτεινή πηγή δεν μπορεί να αντικατασταθεί, επειδή είναι για κατασκευαστικούς λόγους σταθερά συνδεδεμένη με το προϊόν που την περιβάλλει.

Το προϊόν αυτό περιέχει φωτεινή πηγή της τάξης ενεργειακής απόδοσης <E>.

   Η φωτεινή πηγή LED δεν αντικαθίσταται.

### HR:

#### Izvor svjetla :

Izvor svjetla nije zamjenjiv , jer je konstrukcijski pričvršćen na proizvod .

Ovaj proizvod sadržava izvor svjetlosti klase energetske učinkovitosti <E>.

   LED – izvor svjetla nije moguće zamjeniti

### HU:

#### Fényforrás:



A fényforrás nem cserélhető, mert felépítése miatt szilárdan csatlakozik a termékhez. Ez a termék egy <E> energiahatékonysági osztályú fényforrást tartalmaz.

   A fényforrás nem cserélhető

### IS:

#### Ljósgjafi:

Ljósgjafinn er ekki útskiptanlegur vegna þess að hann er háður umliggjandi hönnun vörunnar. Varan inniheldur ljósgjafa í orkuflökki <E>.



   Ekki er hægt að skipta um LED-ljósgjafann.

### IT:

#### Sorgente luminosa:

La sorgente luminosa non è intercambiabile perché è saldamente collegata al prodotto per via del suo design.



Questo prodotto contiene una sorgente luminosa di classe di efficienza energetica <E>.

   La sorgente luminosa a LED non può essere sostituita.

### LT:

#### Šviesos šaltinis:

Šis šviesos šaltinis yra nekeičiamas, nes jis prijungtas prie gaminio pagal jo konstrukciją. Šiame gaminyje yra šviesos šaltinis, kurio energijos vartojimo efektyvumo klasė <E>.

   LED šviesos šaltinis yra nekeičiamas.

### LV:

#### Gaismas avots:

Gaismas avotu nevar nomainīt, jo tas konstrukcijā ir cieši savienots ar izstrādājuma apkārtējo daļu.



Šis ražojums satur gaismas avotu, kura energoefektivitātes klase ir <E>.

   LED apgaismes līdzekļi nevar nomainīt.

### CZ:

#### Zdroj světla:

Světelný zdroj není možné vyměnit, protože je díky své konstrukci pevně spojený s produktem. Tento výrobek obsahuje světelný zdroj s třídou energetické účinnosti <E>.

   Světelný zdroj není vyměnitelný.

### DK:

#### Lyskilde:

Lyskilden kan ikke udskiftes, fordi den er fast forbundet med det omgivende produkt.

Dette produkt indeholder en lyskilde i energieffektivitetsklasse < E > .



   LED- lyskilden kan ikke udskiftes.

### ET:

#### Valgusallikas:

Valgusallikas ei ole välja vahetatav, sest ta on tootega ehituslikult kindlalt seotud.

Toode sisaldab energiatõhususe klassi <E> valgusallikat.



   LED - valgusallikat ei saa asendada.

### ES:

#### Fuente de luz:

La fuente de luz no es sustituible porque está fija en el producto desde la construcción.

Este producto contiene una fuente luminosa de la clase de eficiencia energética <E>.

   Bombilla no reemplazable.

### FI:

#### Valonlähde:

Valonlähdettä ei voi vaihtaa uuteen, sillä se on rakenteellisesti yhdistetty ympäröivään tuotteeseen.

Tämä tuote sisältää valonlähteen, jonka energiatehokkuusluokka on <E>.

   LED-valonlähdettä ei voi vaihtaa uuteen.

### PL:

#### Źródło światła:

Źródła światła nie można wymienić, ponieważ jest zintegrowane z produktem ze względu na swoją konstrukcję.

Ten produkt zawiera źródło światła o klasie efektywności energetycznej <E>.

   LED - źródło światła nie może być wymienione.

### PT:

#### Fonte de Luz:

A fonte de luz não é substituível porque devido às suas características construtivas está fixada de forma permanente ao produto circundante.

Este produto contém uma fonte de luz da classe de eficiência energética <E>.

   Lâmpada não substituível.

### RO:

#### Sursa de lumina:

Sursa de lumina nu este înlocuibilă ea fiind parte constructivă a produsului. Acest produs conține o sursă de lumină cu clasa de eficiență energetică <E>.

   Sursa de lumina nu poate fi înlocuită

### RUS:

#### Источник света:

Источник света не является взаимозаменяемым, поскольку это определяется конструкцией смежного продукта.

Данный продукт содержит источник света класса энергоэффективности <E>.



   Светодиодный источник света не подлежит замене.

### SE:

#### Ljuskälla:

Ljuskällan är inte utbytbar, eftersom den på grund av konstruktionen är fast integrerad i den omgivande produkten.

Denna produkt innehåller en ljuskälla med energieffektivitetsklass <E>.



   LED-ljuskällan kan inte bytas ut.

### SI:

#### Izvor svetlobe:

Vir svetlobe ni zamenljiv, ker je določen z zasnovno izdelka v okolici.

Ta izdelek vsebuje svetlobni vir razreda energijske učinkovitosti <E>.



   Svetlobni vir ni mogoče zamenjati.

### SK:

#### Zdroj svetla:

Svetelný zdroj nie je možné vymeniť, pretože je vďaka svojej konštrukcii pevne spojený s produktom.

Tento výrobok obsahuje svetelný zdroj triedy energetickej účinnosti <E>.



   Svetelný zdroj nie je vymeniteľný.

### SRB:

#### Izvor svetlosti:

Izvor svetlosti nije zamenljiv, jer je zbog svog dizajna čvrsto povezan sa proizvodom koji ga opkružuje.

Ovaj proizvod sadrži izvor svetlosti klase energetske efikasnosti <E>.

   LED izvor svetlosti nije zamenljiv.

**NL:**Lichtbron:

De lichtbron kan niet worden vervangen, omdat deze vanwege de constructie vast met het product eromheen verbonden is.



Dit product bevat een lichtbron van energie-efficiëntieklasse <E>.

  De LED-lichtbron kan niet worden vervangen.

**NO:**Lyskilde:

Lyskilden kan ikke byttes fordi den sitter fast i produktet.



Dette produktet inneholder en lyskilde i energiklasse <E>.

  LED-lyspæren kan ikke byttes.

**TR:**Işık kaynağı:

Konstrüksiyon gereği çevreleyen ürün ile sabit bir şekilde bağlı olduğu için ışık kaynağı değiştirilemez.

Bu ürün, <E> enerji sınıfından bir ışık kaynağına sahiptir.

  LED ışık kaynağı değiştirilemez.

**UK:**Джерело світла:

Джерело світла не можна обміняти, оскільки воно міцно пов'язане з навколишнім виробом завдяки своїй конструкції.

Цей виріб містить джерело світла класу енергоефективності <E>.

  – джерело світлодіодного світла не можна замінювати.